

# Adapters and Couplings



## **FITOK Group**

### **FITOK GmbH (Headquarter)**

Sprendlinger Landstr. 115, 63069 Offenbach am Main, Germany  
Tel.: +49 69 8900 4498 Fax: +49 69 8900 4495

### **FITOK, Inc.**

13843 North Promenade Blvd., Suite 750, Stafford, Texas 77477, USA  
Tel.: +1 281 888 0077 Fax: +1 281 582 4051

### **FITOK Incorporated**

1-4F, Block C, Zone E, Yingtailong Industrial Park, Dalang Street,  
Longhua District, Shenzhen, 518109, China  
Tel.: +86 755 2803 2500 Fax: +86 755 2803 2619

### **FITOK Middle East Oil Equipment Trading LLC**

208-209, Makateb Tower, Airport Road, P.O.Box 185412, Deira, Dubai, UAE  
Tel.: +971 4 2959 853 Fax: +971 4 2959 854

info@fitokgroup.com  
www.fitokgroup.com

FK-IC-HF-05-EN-151014

**FITOK**  
Valves and Fittings

www.fitokgroup.com

# Contents

15 Series Male to 15 Series Male

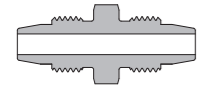

03

15 Series Male to Male NPT Thread

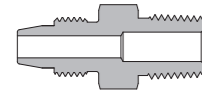

03

15 Series Male to Male JIC

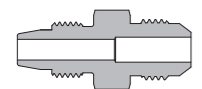

04

15 Series Male to Type "M" Male

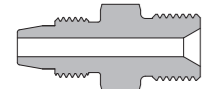

05

20 Series Male to 15 Series Male

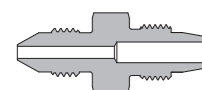

05

20 Series Male to 20 Series Male

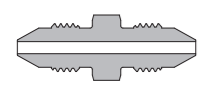

06

20 Series Male to Male NPT Thread

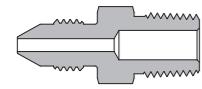

07

20 Series Male to Male JIC

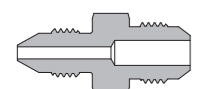

08

20 Series Male to Type "M" Male

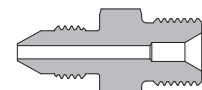

09

60 Series Male to 15 Series Male

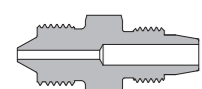

10

60 Series Male to 20 Series Male

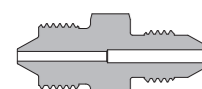

10

60 Series Male to 60 Series Male

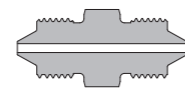

11

60 Series Male to Male NPT Thread

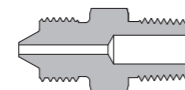

11

60 Series Male to Male JIC

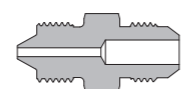

12

60 Series Male to Type "M" Male

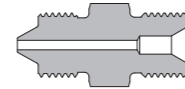

12

Type "M" Male to 20 Series Coned and Threaded Nipples



13

Type "M" Male to 60 Series Coned and Threaded Nipples

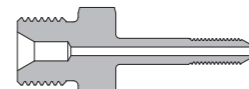

14

20 Series Female to 15 Series Female

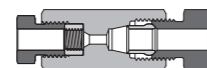

14

20 Series Female to Female NPT Thread

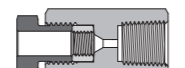

15

60 Series Female to 15 Series Female

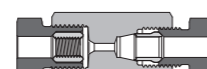

16

60 Series Female to 20 Series Female

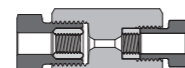

16

60 Series Female to Female NPT Thread

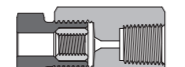

17

# Contents

15 Series Female to 15 Series Male

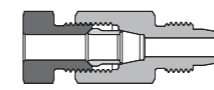

17

15 Series Female to 20 Series Male

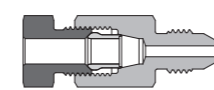

18

15 Series Female to 20 Series Coned and Threaded Nipples

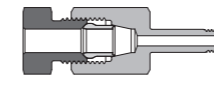

19

15 Series Female to 60 Series Male

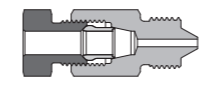

20

15 Series Female to 60 Series Coned and Threaded Nipples

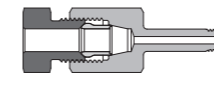

20

15 Series Female to Type "M" Male

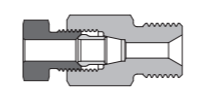

21

20 Series Female to 15 Series Male

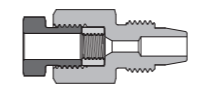

22

20 Series Female to 20 Series Male

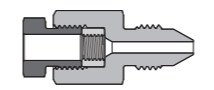

23

20 Series Female to 60 Series Male

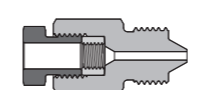

24

20 Series Female to Male NPT Thread

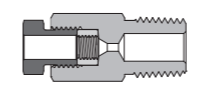

25

20 Series Female to Type "M" Male

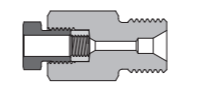

26

60 Series Female to 15 Series Male

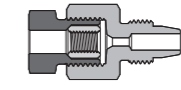

27

60 Series Female to 20 Series Male

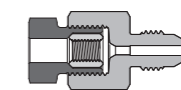

27

60 Series Female to 60 Series Male

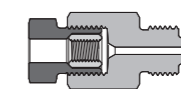

28

60 Series Female to Male NPT Thread

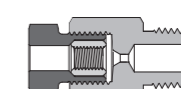

28

60 Series Female to Type "M" Male

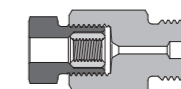

29

Female NPT Thread to 15 Series Male

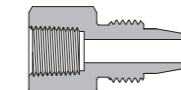

30

Female NPT Thread to 20 Series Male

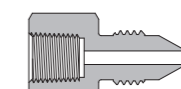

31

Female NPT Thread to 20 Series Coned and Threaded Nipples

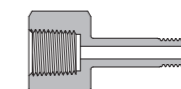

32

Female NPT Thread to 60 Series Male

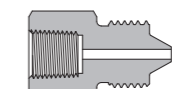

33

Female NPT Thread to 60 Series Coned and Threaded Nipples

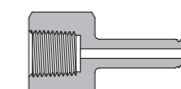

34

## Features

- ◎ The hardened threads with smooth surface finishing avoid galling and help to extend the fitting service life.
- ◎ Every fitting is stamped with size, material, and heat code.
- ◎ 316 stainless steel is standard material. Other materials are available upon request.

## Working Temperature

Connection	Temperature Rating
15 Series Male Ends	-423°F to 1200°F (-252°C to 649°C)
20 Series Male Ends	-423°F to 1200°F (-252°C to 649°C)
60 Series Male Ends	-423°F to 1200°F (-252°C to 649°C)
15 Series Female Ends	=325°F to 800°F (-198°C to 427°C)
20 Series Female Ends	-423°F to 1200°F (-252°C to 649°C)
60 Series Female Ends	-423°F to 1200°F (-252°C to 649°C)
20 Series Coned and Threaded Nipples Ends	-423°F to 1200°F (-252°C to 649°C)
60 Series Coned and Threaded Nipples Ends	-423°F to 1200°F (-252°C to 649°C)
NPT Pipe Thread Ends	-325°F to 400°F (-198°C to 204°C)
JIC (37°Flare)	-423°F to 1200°F (-252°C to 649°C)
Type "M" Male	-423°F to 1200°F (-252°C to 649°C)

## Working Pressure

The working pressures of Adapters and Couplings are shown in the ordering information table.

## Elevated Temperature Factors

To get the maximum working pressure at elevated temperature, use the maximum working pressure at ambient temperature to multiply the factors in the table below.

Material	Temperature		Factor
	°F	°C	
316	100	38	1
	200	93	1
	300	149	1
	400	204	0.97
	500	260	0.90
	600	316	0.85
	700	371	0.82
	800	427	0.80

Date in this table is applied only to the working temperature below 800°F (427°C). For the working temperature above 800°F (427°C) please consult FITOK Group, then we will provide you relative solutions.

## About "CP"

Ordering number with designator "□CP" is for "two-piece" male to male and female to male adapters. They are identical to the "one-piece" designs in length, can be ordered by substituting "CP" for "MP" in the "one-piece" adapter part numbers listed.

For example:

Ordering number of "one-piece": SS-MMA-6MP6-6MP4

The corresponding ordering number of "two-piece" is SS-MMA-6CP6-6CP4.

## Caution:

- ◎ Do not loosen or tighten fittings under pressure.
- ◎ Always use proper thread sealants on tapered pipe threads.

## Adapters and Couplings End Configuration

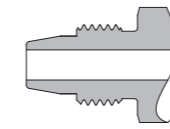

"MP" 15 Series Male

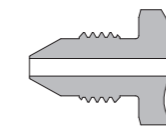

"2MP" 20 Series Male

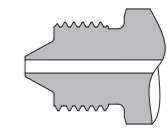

"6MP" 60 Series Male

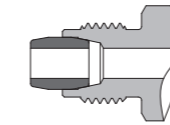

"CP" 15 Series Male

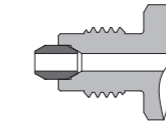

"2CP" 20 Series Male

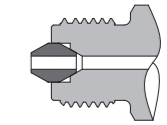

"6CP" 60 Series Male

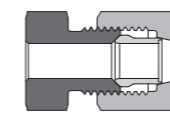

"FH" 15 Series Female

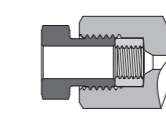

"2FH" 20 Series Female

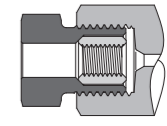

"6FH" 60 Series Female

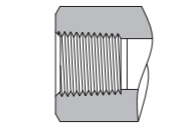

"NS" Female NPT Thread

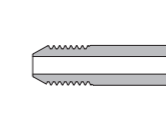

"2CT" 20 Series Coned and Threaded Nipples

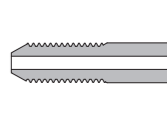

"6CT" 60 Series Coned and Threaded Nipples

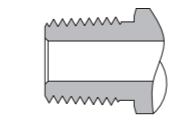

"NS" Male NPT Thread

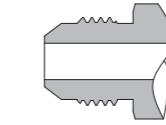

"AN" Male JIC

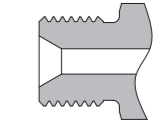

"HM" Type "M" Male

## Thread Sizes:

MP2/CP2/FH2: 3/8-24	2MP4/2CP4/2FH4: 7/16-20	2CT4: 1/4-28	6MP4/6CP4/6FH4: 9/16-18
MP4/CP4/FH4: 1/2-20	2MP6/2CP6/2FH6: 9/16-18	2CT6: 3/8-24	6MP6/6CP6/6FH6: 3/4-16
MP6/CP6/FH6: 5/8-18	2MP9/2CP9/2FH9: 13/16-16	2CT9: 9/16-18	6MP9/6CP9/6FH9: 1-1/8-12
MP8/CP8/FH8: 13/16-16	2MP12/2CP12/2FH12: 3/4-14	2CT12: 3/4-16	6CT4: 1/4-28
	2MP16/2CP16/2FH16: 1-3/8-12	2CT16: 1-14	6CT6: 3/8-24
			6CT9: 9/16-18
NS2: 1/8-27 NPT	AN4: 7/16-20	HM9: 9/16-18	
NS4: 1/4-18 NPT	AN6: 9/16-18	HM12: 3/4-16	
NS6: 3/8-18 NPT	AN8: 3/4-16	HM14: 7/8-14	
NS8: 1/2-14 NPT	AN10: 7/8-14	HM16: 1-12	
NS12: 3/4-14 NPT	AN12: 1-1/16-12	HM21: 1-5/16-12	
NS16: 1-11.5 NPT	AN16: 1-5/16-12		

15 Series Male to 15 Series Male

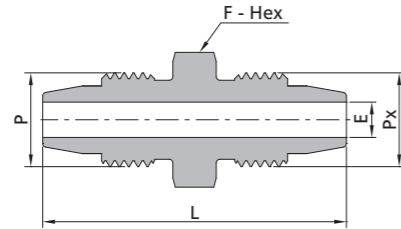

15 Series Male			15 Series Male			
P-Connection Type	Px-Connection Type	Ordering Number	Dimension, in. (mm)			Working Pressure psig (bar)
			L	F	E	
MP2	MP2	SS-MMA-MP2	1.37 (34.9)	0.50 (12.7)	0.09 (2.4)	15000 (1034)
MP4	MP2	SS-MMA-MP4-MP2	1.63 (41.3)	0.63 (15.9)	0.09 (2.4)	15000 (1034)
MP4	MP4	SS-MMA-MP4	1.75 (44.5)	0.63 (15.9)	0.19 (4.8)	15000 (1034)
MP6	MP2	SS-MMA-MP6-MP2	1.69 (42.9)	0.75 (19.1)	0.09 (2.4)	15000 (1034)
MP6	MP4	SS-MMA-MP6-MP4	1.87 (47.6)	0.75 (19.1)	0.19 (4.8)	15000 (1034)
MP6	MP6	SS-MMA-MP6	1.87 (47.6)	0.75 (19.1)	0.25 (6.4)	15000 (1034)
MP8	MP2	SS-MMA-MP8-MP2	1.81 (46.0)	0.94 (23.8)	0.09 (2.4)	15000 (1034)
MP8	MP4	SS-MMA-MP8-MP4	2.00 (50.8)	0.94 (23.8)	0.19 (4.8)	15000 (1034)
MP8	MP6	SS-MMA-MP8-MP6	2.00 (50.8)	0.94 (23.8)	0.25 (6.4)	15000 (1034)
MP8	MP8	SS-MMA-MP8	2.06 (52.4)	0.94 (23.8)	0.37 (9.5)	15000 (1034)

15 Series Male to Male NPT Threads

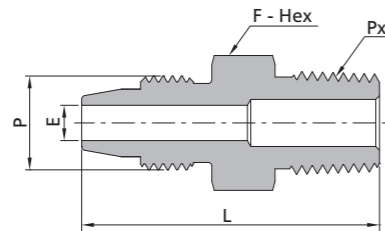

15 Series Male			Male NPT Threads			
P-Connection Type	Px-Connection Type	Ordering Number	Dimension, in. (mm)			Working Pressure psig (bar)
			L	F	E	
MP2	1/8 NPT	SS-MMA-MP2-NS2	1.19 (30.2)	0.50 (12.7)	0.09 (2.4)	15000 (1034)
MP2	1/4 NPT	SS-MMA-MP2-NS4	1.44 (36.5)	0.56 (14.3)	0.09 (2.4)	15000 (1034)
MP2	3/8 NPT	SS-MMA-MP2-NS6	1.50 (38.1)	0.69 (17.5)	0.09 (2.4)	15000 (1034)
MP2	1/2 NPT	SS-MMA-MP2-NS8	1.75 (44.5)	0.87 (22.2)	0.09 (2.4)	15000 (1034)
MP2	3/4 NPT	SS-MMA-MP2-NS12	1.81 (46.0)	1.06 (27.0)	0.09 (2.4)	10000 (690)
MP2	1 NPT	SS-MMA-MP2-NS16	2.13 (54.0)	1.37 (34.9)	0.09 (2.4)	10000 (690)
MP4	1/8 NPT	SS-MMA-MP4-NS2	1.44 (36.5)	0.63 (15.9)	0.19 (4.8)	15000 (1034)
MP4	1/4 NPT	SS-MMA-MP4-NS4	1.63 (41.3)	0.63 (15.9)	0.19 (4.8)	15000 (1034)
MP4	3/8 NPT	SS-MMA-MP4-NS6	1.63 (41.3)	0.69 (17.5)	0.19 (4.8)	15000 (1034)
MP4	1/2 NPT	SS-MMA-MP4-NS8	1.87 (47.6)	0.87 (22.2)	0.19 (4.8)	15000 (1034)
MP4	3/4 NPT	SS-MMA-MP4-NS12	1.94 (49.2)	1.06 (27.0)	0.19 (4.8)	10000 (690)
MP4	1 NPT	SS-MMA-MP4-NS16	2.25 (57.2)	1.37 (34.9)	0.19 (4.8)	10000 (690)

15 Series Male			Male NPT Threads			
P-Connection Type	Px-Connection Type	Ordering Number	Dimension, in. (mm)			Working Pressure psig (bar)
			L	F	E	
MP6	1/8 NPT	SS-MMA-MP6-NS2	1.50 (38.1)	0.75 (19.1)	0.19 (4.8)	15000 (1034)
MP6	1/4 NPT	SS-MMA-MP6-NS4	1.69 (42.9)	0.75 (19.1)	0.25 (6.4)	15000 (1034)
MP6	3/8 NPT	SS-MMA-MP6-NS6	1.69 (42.9)	0.75 (19.1)	0.25 (6.4)	15000 (1034)
MP6	1/2 NPT	SS-MMA-MP6-NS8	1.94 (49.2)	0.87 (22.2)	0.25 (6.4)	15000 (1034)
MP6	3/4 NPT	SS-MMA-MP6-NS12	2.00 (50.8)	1.06 (27.0)	0.25 (6.4)	10000 (690)
MP6	1 NPT	SS-MMA-MP6-NS16	2.31 (58.7)	1.37 (34.9)	0.25 (6.4)	10000 (690)
MP8	1/8 NPT	SS-MMA-MP8-NS2	1.63 (41.3)	0.94 (23.8)	0.19 (4.8)	15000 (1034)
MP8	1/4 NPT	SS-MMA-MP8-NS4	1.81 (46.0)	0.94 (23.8)	0.25 (6.4)	15000 (1034)
MP8	3/8 NPT	SS-MMA-MP8-NS6	1.81 (46.0)	0.94 (23.8)	0.31 (7.9)	15000 (1034)
MP8	1/2 NPT	SS-MMA-MP8-NS8	2.00 (50.8)	0.94 (23.8)	0.37 (9.5)	15000 (1034)
MP8	3/4 NPT	SS-MMA-MP8-NS12	2.06 (52.4)	1.06 (27.0)	0.37 (9.5)	10000 (690)
MP8	1 NPT	SS-MMA-MP8-NS16	2.37 (60.3)	1.37 (34.9)	0.37 (9.5)	10000 (690)

15 Series Male to Male JIC

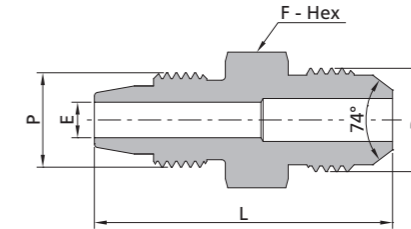

15 Series Male			Male JIC			
P-Connection Type	Px-Connection Type	Ordering Number	Dimension, in. (mm)			Working Pressure psig (bar)
			L	F	E	
MP2	1/4 JIC	SS-MMA-MP2-AN4	1.37 (34.9)	0.50 (12.7)	0.09 (2.4)	15000 (1034)
MP2	3/8 JIC	SS-MMA-MP2-AN6	1.44 (36.5)	0.63 (15.9)	0.09 (2.4)	15000 (1034)
MP2	1/2 JIC	SS-MMA-MP2-AN8	1.63 (41.3)	0.81 (20.6)	0.09 (2.4)	15000 (1034)
MP2	5/8 JIC	SS-MMA-MP2-AN10	1.75 (44.5)	0.94 (23.8)	0.09 (2.4)	15000 (1034)
MP2	3/4 JIC	SS-MMA-MP2-AN12	1.94 (49.2)	1.13 (28.6)	0.09 (2.4)	15000 (1034)
MP2	1 JIC	SS-MMA-MP2-AN16	2.06 (52.4)	1.37 (34.9)	0.09 (2.4)	15000 (1034)
MP4	1/4 JIC	SS-MMA-MP4-AN4	1.63 (41.3)	0.63 (15.9)	0.17 (4.4)	15000 (1034)
MP4	3/8 JIC	SS-MMA-MP4-AN6	1.63 (41.3)	0.63 (15.9)	0.19 (4.8)	15000 (1034)
MP4	1/2 JIC	SS-MMA-MP4-AN8	1.75 (44.5)	0.81 (20.6)	0.19 (4.8)	15000 (1034)
MP4	5/8 JIC	SS-MMA-MP4-AN10	1.94 (49.2)	0.94 (23.8)	0.19 (4.8)	15000 (1034)
MP4	3/4 JIC	SS-MMA-MP4-AN12	2.06 (52.4)	1.13 (28.6)	0.19 (4.8)	15000 (1034)
MP4	1 JIC	SS-MMA-MP4-AN16	2.25 (57.2)	1.37 (34.9)	0.19 (4.8)	15000 (1034)
MP6	1/4 JIC	SS-MMA-MP6-AN4	1.69 (42.9)	0.75 (19.1)	0.17 (4.4)	15000 (1034)
MP6	3/8 JIC	SS-MMA-MP6-AN6	1.69 (42.9)	0.75 (19.1)	0.23 (5.8)	15000 (1034)
MP6	1/2 JIC	SS-MMA-MP6-AN8	1.81 (46.0)	0.81 (20.6)	0.25 (6.4)	15000 (1034)
MP6	5/8 JIC	SS-MMA-MP6-AN10	1.94 (49.2)	0.94 (23.8)	0.25 (6.4)	15000 (1034)
MP6	3/4 JIC	SS-MMA-MP6-AN12	2.13 (54.0)	1.13 (28.6)	0.25 (6.4)	15000 (1034)
MP6	1 JIC	SS-MMA-MP6-AN16	2.25 (57.2)	1.37 (34.9)	0.25 (6.4)	15000 (1034)
MP8	1/4 JIC	SS-MMA-MP8-AN4	1.81 (46.0)	0.94 (23.8)	0.17 (4.4)	15000 (1034)
MP8	3/8 JIC	SS-MMA-MP8-AN6	1.81 (46.0)	0.94 (23.8)	0.23 (5.8)	15000 (1034)
MP8	1/2 JIC	SS-MMA-MP8-AN8	1.94 (49.2)	0.94 (23.8)	0.31 (8.0)	15000 (1034)
MP8	5/8 JIC	SS-MMA-MP8-AN10	2.00 (50.8)	0.94 (23.8)	0.37 (9.4)	15000 (1034)
MP8	3/4 JIC	SS-MMA-MP8-AN12	2.19 (55.6)	1.13 (28.6)	0.37 (9.5)	15000 (1034)
MP8	1 JIC	SS-MMA-MP8-AN16	2.31 (58.7)	1.37 (34.9)	0.37 (9.5)	15000 (1034)

15 Series Male to Type "M" Male

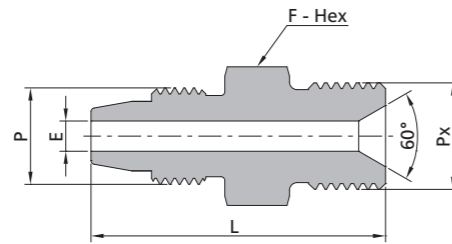

15 Series Male			Type "M" Male			
P-Connection Type	Px-Connection Type	Ordering Number	Dimension, in. (mm)			Working Pressure psig (bar)
			L	F	E	
MP2	HM9	SS-MMA-MP2-HM9	1.38 (35.1)	0.63 (15.9)	0.09 (2.4)	15000 (1034)
MP2	HM12	SS-MMA-MP2-HM12	1.55 (39.4)	0.75 (19.1)	0.09 (2.4)	15000 (1034)
MP2	HM14	SS-MMA-MP2-HM14	1.76 (44.6)	1.00 (25.4)	0.09 (2.4)	15000 (1034)
MP2	HM16	SS-MMA-MP2-HM16	1.64 (41.7)	1.00 (25.4)	0.09 (2.4)	15000 (1034)
MP2	HM21	SS-MMA-MP2-HM21	1.76 (44.7)	1.37 (34.9)	0.09 (2.4)	15000 (1034)
MP4	HM9	SS-MMA-MP4-HM9	1.54 (39.0)	0.63 (15.9)	0.09 (2.4)	15000 (1034)
MP4	HM12	SS-MMA-MP4-HM12	1.70 (43.3)	0.75 (19.1)	0.19 (4.8)	15000 (1034)
MP4	HM14	SS-MMA-MP4-HM14	1.91 (48.5)	1.00 (25.4)	0.15 (3.8)	15000 (1034)
MP4	HM16	SS-MMA-MP4-HM16	1.80 (45.6)	1.00 (25.4)	0.19 (4.8)	15000 (1034)
MP4	HM21	SS-MMA-MP4-HM21	1.91 (48.6)	1.37 (34.9)	0.19 (4.8)	15000 (1034)
MP6	HM9	SS-MMA-MP6-HM9	1.63 (41.3)	0.75 (19.1)	0.09 (2.4)	15000 (1034)
MP6	HM12	SS-MMA-MP6-HM12	1.76 (44.6)	0.75 (19.1)	0.25 (6.4)	15000 (1034)
MP6	HM14	SS-MMA-MP6-HM14	1.95 (49.6)	1.00 (25.4)	0.15 (3.8)	15000 (1034)
MP6	HM16	SS-MMA-MP6-HM16	1.85 (46.9)	1.00 (25.4)	0.25 (6.4)	15000 (1034)
MP6	HM21	SS-MMA-MP6-HM21	1.96 (49.9)	1.37 (34.9)	0.25 (6.4)	15000 (1034)
MP8	HM9	SS-MMA-MP8-HM9	1.73 (44.0)	0.94 (23.8)	0.09 (2.4)	15000 (1034)
MP8	HM12	SS-MMA-MP8-HM12	1.86 (47.3)	0.94 (23.8)	0.29 (7.4)	15000 (1034)
MP8	HM14	SS-MMA-MP8-HM14	2.01 (51.1)	1.00 (25.4)	0.15 (3.8)	15000 (1034)
MP8	HM16	SS-MMA-MP8-HM16	1.90 (48.2)	1.00 (25.4)	0.37 (9.5)	15000 (1034)
MP8	HM21	SS-MMA-MP8-HM21	2.02 (51.2)	1.37 (34.9)	0.37 (9.5)	15000 (1034)

20 Series Male to 15 Series Male

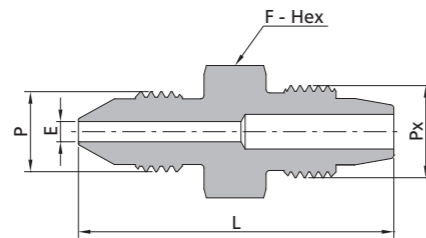

20 Series Male			15 Series Male			
P-Connection Type	Px-Connection Type	Ordering Number	Dimension, in. (mm)			Working Pressure psig (bar)
			L	F	E	
2MP4	MP2	SS-MMA-2MP4-MP2	1.50 (38.1)	0.50 (12.7)	0.09 (2.4)	15000 (1034)
2MP4	MP4	SS-MMA-2MP4-MP4	1.75 (44.5)	0.63 (15.9)	0.11 (2.8)	15000 (1034)
2MP4	MP6	SS-MMA-2MP4-MP6	1.81 (46.0)	0.75 (19.1)	0.11 (2.8)	15000 (1034)
2MP4	MP8	SS-MMA-2MP4-MP8	1.94 (49.2)	0.94 (23.8)	0.11 (2.8)	15000 (1034)
2MP6	MP2	SS-MMA-2MP6-MP2	1.75 (44.5)	0.63 (15.9)	0.09 (2.4)	15000 (1034)
2MP6	MP4	SS-MMA-2MP6-MP4	1.87 (47.6)	0.63 (15.9)	0.19 (4.8)	15000 (1034)

20 Series Male			15 Series Male			
P-Connection Type	Px-Connection Type	Ordering Number	Dimension, in. (mm)			Working Pressure psig (bar)
			L	F	E	
2MP6	MP6	SS-MMA-2MP6-MP6	1.94 (49.2)	0.75 (19.1)	0.20 (5.2)	15000 (1034)
2MP6	MP8	SS-MMA-2MP6-MP8	2.06 (52.4)	0.94 (23.8)	0.20 (5.2)	15000 (1034)
2MP9	MP2	SS-MMA-2MP9-MP2	2.00 (50.8)	0.94 (23.8)	0.09 (2.4)	15000 (1034)
2MP9	MP4	SS-MMA-2MP9-MP4	2.19 (55.6)	0.94 (23.8)	0.19 (4.8)	15000 (1034)
2MP9	MP6	SS-MMA-2MP9-MP6	2.19 (55.6)	0.94 (23.8)	0.25 (6.4)	15000 (1034)
2MP9	MP8	SS-MMA-2MP9-MP8	2.25 (57.2)	0.94 (23.8)	0.31 (7.9)	15000 (1034)
2MP12	MP2	SS-MMA-2MP12-MP2	2.25 (57.2)	1.19 (30.2)	0.09 (2.4)	15000 (1034)
2MP12	MP4	SS-MMA-2MP12-MP4	2.44 (61.9)	1.19 (30.2)	0.19 (4.8)	15000 (1034)
2MP12	MP6	SS-MMA-2MP12-MP6	2.50 (63.5)	1.19 (30.2)	0.25 (6.4)	15000 (1034)
2MP12	MP8	SS-MMA-2MP12-MP8	2.50 (63.5)	1.19 (30.2)	0.37 (9.5)	15000 (1034)
2MP16	MP2	SS-MMA-2MP16-MP2	2.81 (71.4)	1.50 (38.1)	0.09 (2.4)	15000 (1034)
2MP16	MP4	SS-MMA-2MP16-MP4	3.00 (76.2)	1.50 (38.1)	0.19 (4.8)	15000 (1034)
2MP16	MP6	SS-MMA-2MP16-MP6	3.06 (77.8)	1.50 (38.1)	0.37 (9.5)	15000 (1034)
2MP16	MP8	SS-MMA-2MP16-MP8	3.06 (77.8)	1.50 (38.1)	0.37 (9.5)	15000 (1034)

20 Series Male to 20 Series Male

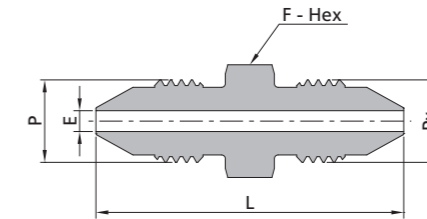

20 Series Male			20 Series Male			
P-Connection Type	Px-Connection Type	Ordering Number	Dimension, in. (mm)			Working Pressure psig (bar)
			L	F	E	
2MP4	2MP4	SS-MMA-2MP4	1.63 (41.3)	0.50 (12.7)	0.11 (2.8)	20000 (1379)
2MP6	2MP4	SS-MMA-2MP6-2MP4	1.87 (47.6)	0.63 (15.9)	0.11 (2.8)	20000 (1379)
2MP6	2MP6	SS-MMA-2MP6	2.00 (50.8)	0.63 (15.9)	0.20 (5.2)	20000 (1379)
2MP9	2MP4	SS-MMA-2MP9-2MP4	2.13 (54.0)	0.94 (23.8)	0.11 (2.8)	20000 (1379)
2MP9	2MP6	SS-MMA-2MP9-2MP6	2.31 (58.7)	0.94 (23.8)	0.20 (5.2)	20000 (1379)
2MP9	2MP9	SS-MMA-2MP9	2.50 (63.5)	0.94 (23.8)	0.31 (7.9)	20000 (1379)
2MP12	2MP4	SS-MMA-2MP12-2MP4	2.44 (61.9)	1.19 (30.2)	0.11 (2.8)	20000 (1379)
2MP12	2MP6	SS-MMA-2MP12-2MP6	2.56 (65.1)	1.19 (30.2)	0.20 (5.2)	20000 (1379)
2MP12	2MP9	SS-MMA-2MP12-2MP9	2.75 (69.9)	1.19 (30.2)	0.31 (7.9)	20000 (1379)
2MP12	2MP12	SS-MMA-2MP12	2.94 (74.6)	1.19 (30.2)	0.44 (11.1)	20000 (1379)
2MP16	2MP4	SS-MMA-2MP16-2MP4	3.00 (76.2)	1.50 (38.1)	0.11 (2.8)	20000 (1379)
2MP16	2MP6	SS-MMA-2MP16-2MP6	3.13 (79.4)	1.50 (38.1)	0.20 (5.2)	20000 (1379)
2MP16	2MP9	SS-MMA-2MP16-2MP9	3.31 (84.2)	1.50 (38.1)	0.31 (7.9)	20000 (1379)
2MP16	2MP12	SS-MMA-2MP16-2MP12	3.44 (87.4)	1.50 (38.1)	0.44 (11.1)	20000 (1379)
2MP16	2MP16	SS-MMA-2MP16	3.94 (100.2)	1.50 (38.1)	0.56 (14.3)	20000 (1379)



20 Series Male to Male NPT Threads

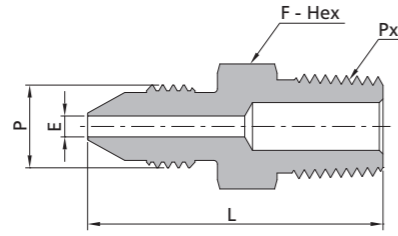

20 Series Male			Male NPT Threads			
P-Connection Type	Px-Connection Type	Ordering Number	Dimension, in. (mm)			Working Pressure psig (bar)
			L	F	E	
2MP4	1/8 NPT	SS-MMA-2MP4-NS2	1.37 (34.9)	0.50 (12.7)	0.11 (2.8)	15000 (1034)
2MP4	1/4 NPT	SS-MMA-2MP4-NS4	1.56 (39.7)	0.56 (14.3)	0.11 (2.8)	15000 (1034)
2MP4	3/8 NPT	SS-MMA-2MP4-NS6	1.63 (41.3)	0.69 (17.5)	0.11 (2.8)	15000 (1034)
2MP4	1/2 NPT	SS-MMA-2MP4-NS8	1.87 (47.6)	0.87 (22.2)	0.11 (2.8)	15000 (1034)
2MP4	3/4 NPT	SS-MMA-2MP4-NS12	1.94 (49.2)	1.06 (27.0)	0.11 (2.8)	10000 (690)
2MP4	1 NPT	SS-MMA-2MP4-NS16	2.25 (57.2)	1.37 (34.9)	0.11 (2.8)	10000 (690)
2MP6	1/8 NPT	SS-MMA-2MP6-NS2	1.56 (39.7)	0.63 (15.9)	0.19 (4.8)	15000 (1034)
2MP6	1/4 NPT	SS-MMA-2MP6-NS4	1.75 (44.5)	0.63 (15.9)	0.20 (5.2)	15000 (1034)
2MP6	3/8 NPT	SS-MMA-2MP6-NS6	1.75 (44.5)	0.69 (17.5)	0.20 (5.2)	15000 (1034)
2MP6	1/2 NPT	SS-MMA-2MP6-NS8	2.00 (50.8)	0.87 (22.2)	0.20 (5.2)	15000 (1034)
2MP6	3/4 NPT	SS-MMA-2MP6-NS12	2.06 (52.4)	1.06 (27.0)	0.20 (5.2)	10000 (690)
2MP6	1 NPT	SS-MMA-2MP6-NS16	2.37 (60.3)	1.37 (34.9)	0.20 (5.2)	10000 (690)
2MP9	1/8 NPT	SS-MMA-2MP9-NS2	1.87 (47.6)	0.94 (23.8)	0.19 (4.8)	15000 (1034)
2MP9	1/4 NPT	SS-MMA-2MP9-NS4	2.06 (52.4)	0.94 (23.8)	0.25 (6.4)	15000 (1034)
2MP9	3/8 NPT	SS-MMA-2MP9-NS6	2.06 (52.4)	0.94 (23.8)	0.31 (7.9)	15000 (1034)
2MP9	1/2 NPT	SS-MMA-2MP9-NS8	2.25 (57.2)	0.94 (23.8)	0.31 (7.9)	15000 (1034)
2MP9	3/4 NPT	SS-MMA-2MP9-NS12	2.31 (58.7)	1.06 (27.0)	0.31 (7.9)	10000 (690)
2MP9	1 NPT	SS-MMA-2MP9-NS16	2.56 (65.1)	1.37 (34.9)	0.31 (7.9)	10000 (690)
2MP12	1/8 NPT	SS-MMA-2MP12-NS2	2.13 (54.0)	1.19 (30.2)	0.19 (4.8)	15000 (1034)
2MP12	1/4 NPT	SS-MMA-2MP12-NS4	2.31 (58.7)	1.19 (30.2)	0.25 (6.4)	15000 (1034)
2MP12	3/8 NPT	SS-MMA-2MP12-NS6	2.31 (58.7)	1.19 (30.2)	0.31 (7.9)	15000 (1034)
2MP12	1/2 NPT	SS-MMA-2MP12-NS8	2.50 (63.5)	1.19 (30.2)	0.38 (9.6)	15000 (1034)
2MP12	3/4 NPT	SS-MMA-2MP12-NS12	2.50 (63.5)	1.19 (30.2)	0.44 (11.1)	10000 (690)
2MP12	1 NPT	SS-MMA-2MP12-NS16	2.75 (69.9)	1.37 (34.9)	0.44 (11.1)	10000 (690)
2MP16	1/8 NPT	SS-MMA-2MP16-NS2	2.69 (68.3)	1.50 (38.1)	0.19 (4.8)	15000 (1034)
2MP16	1/4 NPT	SS-MMA-2MP16-NS4	2.81 (71.4)	1.50 (38.1)	0.25 (6.4)	15000 (1034)
2MP16	3/8 NPT	SS-MMA-2MP16-NS6	2.81 (71.4)	1.50 (38.1)	0.31 (7.9)	15000 (1034)
2MP16	1/2 NPT	SS-MMA-2MP16-NS8	3.06 (77.8)	1.50 (38.1)	0.38 (9.6)	15000 (1034)
2MP16	3/4 NPT	SS-MMA-2MP16-NS12	3.06 (82.6)	1.50 (38.1)	0.56 (14.3)	10000 (690)
2MP16	1 NPT	SS-MMA-2MP16-NS16	3.25 (82.6)	1.50 (38.1)	0.56 (14.3)	10000 (690)

20 Series Male to Male JIC

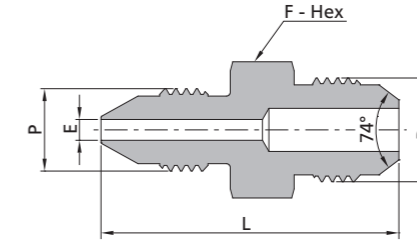

20 Series Male			Male JIC			
P-Connection Type	Px-Connection Type	Ordering Number	Dimension, in. (mm)			Working Pressure psig (bar)
			L	F	E	
2MP4	1/4 JIC	SS-MMA-2MP4-AN4	1.50 (38.1)	0.50 (12.7)	0.11 (2.8)	20000 (1379)
2MP4	3/8 JIC	SS-MMA-2MP4-AN6	1.63 (41.3)	0.63 (15.9)	0.11 (2.8)	20000 (1379)
2MP4	1/2 JIC	SS-MMA-2MP4-AN8	1.75 (44.5)	0.81 (20.6)	0.11 (2.8)	20000 (1379)
2MP4	5/8 JIC	SS-MMA-2MP4-AN10	1.87 (47.6)	0.94 (23.8)	0.11 (2.8)	20000 (1379)
2MP4	3/4 JIC	SS-MMA-2MP4-AN12	2.06 (52.4)	1.13 (28.6)	0.11 (2.8)	15000 (1034)
2MP4	1 JIC	SS-MMA-2MP4-AN16	2.19 (55.6)	1.37 (34.9)	0.11 (2.8)	15000 (1034)
2MP6	1/4 JIC	SS-MMA-2MP6-AN4	1.75 (44.5)	0.63 (15.9)	0.17 (4.4)	20000 (1379)
2MP6	3/8 JIC	SS-MMA-2MP6-AN6	1.75 (44.5)	0.63 (15.9)	0.20 (5.2)	20000 (1379)
2MP6	1/2 JIC	SS-MMA-2MP6-AN8	1.87 (47.6)	0.81 (20.6)	0.20 (5.2)	20000 (1379)
2MP6	5/8 JIC	SS-MMA-2MP6-AN10	2.06 (52.4)	0.94 (23.8)	0.20 (5.2)	20000 (1379)
2MP6	3/4 JIC	SS-MMA-2MP6-AN12	2.25 (57.2)	1.13 (28.6)	0.20 (5.2)	15000 (1034)
2MP6	1 JIC	SS-MMA-2MP6-AN16	2.37 (60.3)	1.37 (34.9)	0.20 (5.2)	15000 (1034)
2MP9	1/4 JIC	SS-MMA-2MP9-AN4	2.00 (50.8)	0.94 (23.8)	0.17 (4.4)	20000 (1379)
2MP9	3/8 JIC	SS-MMA-2MP9-AN6	2.06 (52.4)	0.94 (23.8)	0.23 (5.8)	20000 (1379)
2MP9	1/2 JIC	SS-MMA-2MP9-AN8	2.13 (54.0)	0.94 (23.8)	0.31 (7.9)	20000 (1379)
2MP9	5/8 JIC	SS-MMA-2MP9-AN10	2.25 (57.2)	0.94 (23.8)	0.31 (7.9)	20000 (1379)
2MP9	3/4 JIC	SS-MMA-2MP9-AN12	2.44 (61.9)	1.13 (28.6)	0.31 (7.9)	15000 (1034)
2MP9	1 JIC	SS-MMA-2MP9-AN16	2.56 (65.1)	1.37 (34.9)	0.31 (7.9)	15000 (1034)
2MP12	1/4 JIC	SS-MMA-2MP12-AN4	2.31 (58.7)	1.19 (30.2)	0.17 (4.4)	20000 (1379)
2MP12	3/8 JIC	SS-MMA-2MP12-AN6	2.31 (58.7)	1.19 (30.2)	0.23 (5.8)	20000 (1379)
2MP12	1/2 JIC	SS-MMA-2MP12-AN8	2.37 (60.3)	1.19 (30.2)	0.31 (7.9)	20000 (1379)
2MP12	5/8 JIC	SS-MMA-2MP12-AN10	2.50 (63.5)	1.19 (30.2)	0.37 (9.4)	20000 (1379)
2MP12	3/4 JIC	SS-MMA-2MP12-AN12	2.63 (66.7)	1.19 (30.2)	0.44 (11.1)	15000 (1034)
2MP12	1 JIC	SS-MMA-2MP12-AN16	2.69 (68.3)	1.37 (34.9)	0.44 (11.1)	15000 (1034)
2MP16	1/4 JIC	SS-MMA-2MP16-AN4	2.81 (71.4)	1.50 (38.1)	0.17 (4.4)	20000 (1379)
2MP16	3/8 JIC	SS-MMA-2MP16-AN6	2.81 (71.4)	1.50 (38.1)	0.23 (5.8)	20000 (1379)
2MP16	1/2 JIC	SS-MMA-2MP16-AN8	2.94 (74.6)	1.50 (38.1)	0.31 (7.9)	20000 (1379)
2MP16	5/8 JIC	SS-MMA-2MP16-AN10	3.06 (77.8)	1.50 (38.1)	0.37 (9.4)	20000 (1379)
2MP16	3/4 JIC	SS-MMA-2MP16-AN12	3.13 (79.4)	1.50 (38.1)	0.46 (11.6)	15000 (1034)
2MP16	1 JIC	SS-MMA-2MP16-AN16	3.19 (81.0)	1.50 (38.1)	0.56 (14.3)	15000 (1034)

20 Series Male to Type "M" Male

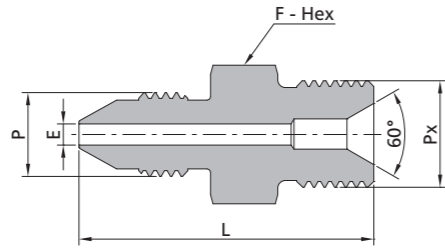

20 Series Male			Type "M" Male			
P-Connection Type	Px-Connection Type	Ordering Number	Dimension, in. (mm)			Working Pressure psig (bar)
			L	F	E	
2MP4	HM9	SS-MMA-2MP4-HM9	1.52 (38.7)	0.63 (15.9)	0.09 (2.4)	20000 (1379)
2MP4	HM12	SS-MMA-2MP4-HM12	1.69 (43.0)	0.75 (19.1)	0.11 (2.8)	20000 (1379)
2MP4	HM14	SS-MMA-2MP4-HM14	1.90 (48.2)	1.00 (25.4)	0.11 (2.8)	20000 (1379)
2MP4	HM16	SS-MMA-2MP4-HM16	1.78 (45.3)	1.00 (25.4)	0.11 (2.8)	20000 (1379)
2MP4	HM21	SS-MMA-2MP4-HM21	1.90 (48.3)	1.37 (34.9)	0.11 (2.8)	20000 (1379)
2MP6	HM9	SS-MMA-2MP6-HM9	1.67 (42.4)	0.63 (15.9)	0.09 (2.4)	20000 (1379)
2MP6	HM12	SS-MMA-2MP6-HM12	1.84 (46.7)	0.75 (19.1)	0.20 (5.2)	20000 (1379)
2MP6	HM14	SS-MMA-2MP6-HM14	2.04 (51.9)	1.00 (25.4)	0.15 (3.8)	20000 (1379)
2MP6	HM16	SS-MMA-2MP6-HM16	1.93 (49.0)	1.00 (25.4)	0.20 (5.2)	20000 (1379)
2MP6	HM21	SS-MMA-2MP6-HM21	2.05 (52.0)	1.37 (34.9)	0.20 (5.2)	20000 (1379)
2MP9	HM9	SS-MMA-2MP9-HM9	1.95 (49.6)	0.94 (23.8)	0.09 (2.4)	20000 (1379)
2MP9	HM12	SS-MMA-2MP9-HM12	2.08 (52.9)	0.94 (23.8)	0.29 (7.4)	20000 (1379)
2MP9	HM14	SS-MMA-2MP9-HM14	2.23 (56.7)	1.00 (25.4)	0.15 (3.8)	20000 (1379)
2MP9	HM16	SS-MMA-2MP9-HM16	2.12 (53.8)	1.00 (25.4)	0.31 (7.9)	20000 (1379)
2MP9	HM21	SS-MMA-2MP9-HM21	2.24 (56.8)	1.37 (34.9)	0.31 (7.9)	20000 (1379)
2MP12	HM9	SS-MMA-2MP12-HM9	2.22 (56.3)	1.19 (30.2)	0.09 (2.4)	20000 (1379)
2MP12	HM12	SS-MMA-2MP12-HM12	2.35 (59.6)	1.19 (30.2)	0.29 (7.4)	20000 (1379)
2MP12	HM14	SS-MMA-2MP12-HM14	2.47 (62.8)	1.19 (30.2)	0.15 (3.8)	20000 (1379)
2MP12	HM16	SS-MMA-2MP12-HM16	2.36 (59.9)	1.19 (30.2)	0.39 (10.0)	20000 (1379)
2MP12	HM21	SS-MMA-2MP12-HM21	2.41 (61.1)	1.37 (34.9)	0.44 (11.1)	20000 (1379)
2MP16	HM9	SS-MMA-2MP16-HM9	2.77 (70.3)	1.50 (38.1)	0.09 (2.4)	20000 (1379)
2MP16	HM12	SS-MMA-2MP16-HM12	2.90 (73.6)	1.50 (38.1)	0.29 (7.4)	20000 (1379)
2MP16	HM14	SS-MMA-2MP16-HM14	3.02 (76.8)	1.50 (38.1)	0.15 (3.8)	20000 (1379)
2MP16	HM16	SS-MMA-2MP16-HM16	2.91 (73.9)	1.50 (38.1)	0.39 (10.0)	20000 (1379)
2MP16	HM21	SS-MMA-2MP16-HM21	2.89 (73.3)	1.50 (38.1)	0.56 (14.3)	20000 (1379)

60 Series Male to 15 Series Male

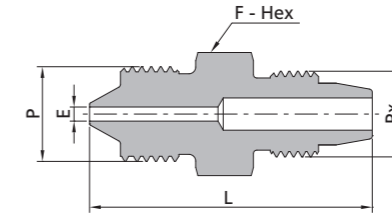

60 Series Male			15 Series Male			
P-Connection Type	Px-Connection Type	Ordering Number	Dimension, in. (mm)			Working Pressure psig (bar)
			L	F	E	
6MP4	MP2	SS-MMA-6MP4-MP2	1.50 (38.1)	0.63 (15.9)	0.08 (2.1)	15000 (1034)
6MP4	MP4	SS-MMA-6MP4-MP4	1.69 (42.9)	0.63 (15.9)	0.08 (2.1)	15000 (1034)
6MP4	MP6	SS-MMA-6MP4-MP6	1.75 (44.5)	0.75 (19.1)	0.08 (2.1)	15000 (1034)
6MP4	MP8	SS-MMA-6MP4-MP8	1.87 (47.6)	0.94 (23.8)	0.08 (2.1)	15000 (1034)
6MP6	MP2	SS-MMA-6MP6-MP2	1.81 (46.0)	0.81 (20.6)	0.09 (2.4)	15000 (1034)
6MP6	MP4	SS-MMA-6MP6-MP4	2.00 (50.8)	0.81 (20.6)	0.13 (3.2)	15000 (1034)
6MP6	MP6	SS-MMA-6MP6-MP6	2.06 (52.4)	0.81 (20.6)	0.13 (3.2)	15000 (1034)
6MP6	MP8	SS-MMA-6MP6-MP8	2.13 (54.0)	0.94 (23.8)	0.13 (3.2)	15000 (1034)
6MP9	MP2	SS-MMA-6MP9-MP2	2.13 (54.0)	1.19 (30.2)	0.09 (2.4)	15000 (1034)
6MP9	MP4	SS-MMA-6MP9-MP4	2.31 (58.7)	1.19 (30.2)	0.19 (4.8)	15000 (1034)
6MP9	MP6	SS-MMA-6MP9-MP6	2.31 (58.7)	1.19 (30.2)	0.19 (4.8)	15000 (1034)
6MP9	MP8	SS-MMA-6MP9-MP8	2.37 (60.3)	1.19 (30.2)	0.19 (4.8)	15000 (1034)

60 Series Male to 20 Series Male

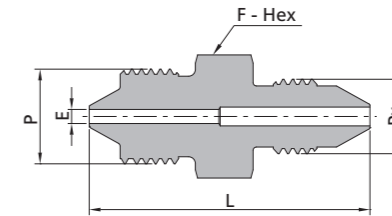

60 Series Male			20 Series Male			
P-Connection Type	Px-Connection Type	Ordering Number	Dimension, in. (mm)			Working Pressure psig (bar)
			L	F	E	
6MP4	2MP4	SS-MMA-6MP4-2MP4	1.69 (42.9)	0.63 (15.9)	0.08 (2.1)	20000 (1379)
6MP4	2MP6	SS-MMA-6MP4-2MP6	1.81 (46.0)	0.63 (15.9)	0.08 (2.1)	20000 (1379)
6MP4	2MP9	SS-MMA-6MP4-2MP9	2.06 (52.4)	0.94 (23.8)	0.08 (2.1)	20000 (1379)
6MP4	2MP12	SS-MMA-6MP4-2MP12	2.37 (60.3)	1.19 (30.2)	0.08 (2.1)	20000 (1379)
6MP4	2MP16	SS-MMA-6MP4-2MP16	2.94 (74.6)	1.50 (38.1)	0.08 (2.1)	20000 (1379)
6MP6	2MP4	SS-MMA-6MP6-2MP4	2.00 (50.8)	0.81 (20.6)	0.11 (2.8)	20000 (1379)
6MP6	2MP6	SS-MMA-6MP6-2MP6	2.13 (54.0)	0.81 (20.6)	0.13 (3.2)	20000 (1379)
6MP6	2MP9	SS-MMA-6MP6-2MP9	2.37 (60.3)	0.94 (23.8)	0.13 (3.2)	20000 (1379)
6MP6	2MP12	SS-MMA-6MP6-2MP12	2.63 (66.7)	1.19 (30.2)	0.13 (3.2)	20000 (1379)
6MP6	2MP16	SS-MMA-6MP6-2MP16	3.13 (79.4)	1.50 (38.1)	0.13 (3.2)	20000 (1379)
6MP9	2MP4	SS-MMA-6MP9-2MP4	2.25 (57.2)	1.19 (30.2)	0.11 (2.8)	20000 (1379)
6MP9	2MP6	SS-MMA-6MP9-2MP6	2.44 (61.9)	1.19 (30.2)	0.19 (4.8)	20000 (1379)
6MP9	2MP9	SS-MMA-6MP9-2MP9	2.63 (66.7)	1.19 (30.2)	0.19 (4.8)	20000 (1379)
6MP9	2MP12	SS-MMA-6MP9-2MP12	2.80 (71.0)	1.19 (30.2)	0.19 (4.8)	20000 (1379)
6MP9	2MP16	SS-MMA-6MP9-2MP16	3.31 (84.2)	1.50 (38.1)	0.19 (4.8)	20000 (1379)

60 Series Male to 60 Series Male

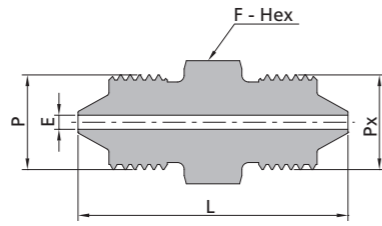

60 Series Male			60 Series Male			
P-Connection Type	Px-Connection Type	Ordering Number	Dimension, in. (mm)			Working Pressure psig (bar)
			L	F	E	
6MP4	6MP4	SS-MMA-6MP4	1.63 (41.3)	0.63 (15.9)	0.08 (2.1)	60000 (4137)
6MP6	6MP4	SS-MMA-6MP6-6MP4	1.94 (49.2)	0.81 (20.6)	0.08 (2.1)	60000 (4137)
6MP6	6MP6	SS-MMA-6MP6	2.19 (55.6)	0.81 (20.6)	0.13 (3.2)	60000 (4137)
6MP9	6MP4	SS-MMA-6MP9-6MP4	2.19 (55.6)	1.19 (30.2)	0.08 (2.1)	60000 (4137)
6MP9	6MP6	SS-MMA-6MP9-6MP6	2.50 (63.5)	1.19 (30.2)	0.13 (3.2)	60000 (4137)
6MP9	6MP9	SS-MMA-6MP9	2.63 (66.7)	1.19 (30.2)	0.19 (4.8)	60000 (4137)

60 Series Male to Male NPT Threads

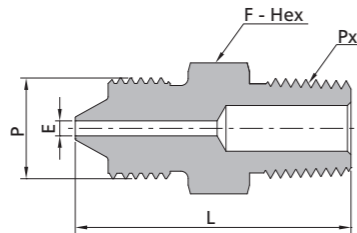

60 Series Male			Male NPT Threads			
P-Connection Type	Px-Connection Type	Ordering Number	Dimension, in. (mm)			Working Pressure psig (bar)
			L	F	E	
6MP4	1/8 NPT	SS-MMA-6MP4-NS2	1.37 (34.9)	0.63 (15.9)	0.08 (2.1)	15000 (1034)
6MP4	1/4 NPT	SS-MMA-6MP4-NS4	1.56 (39.7)	0.63 (15.9)	0.08 (2.1)	15000 (1034)
6MP4	3/8 NPT	SS-MMA-6MP4-NS6	1.56 (39.7)	0.69 (17.5)	0.08 (2.1)	15000 (1034)
6MP4	1/2 NPT	SS-MMA-6MP4-NS8	1.81 (46.0)	0.87 (22.2)	0.08 (2.1)	15000 (1034)
6MP4	3/4 NPT	SS-MMA-6MP4-NS12	1.87 (47.6)	1.06 (27.0)	0.08 (2.1)	10000 (690)
6MP4	1 NPT	SS-MMA-6MP4-NS16	2.19 (55.6)	1.37 (34.9)	0.08 (2.1)	10000 (690)
6MP6	1/8 NPT	SS-MMA-6MP6-NS2	1.69 (42.9)	0.81 (20.6)	0.13 (3.2)	15000 (1034)
6MP6	1/4 NPT	SS-MMA-6MP6-NS4	1.87 (47.6)	0.81 (20.6)	0.13 (3.2)	15000 (1034)
6MP6	3/8 NPT	SS-MMA-6MP6-NS6	1.87 (47.6)	0.81 (20.6)	0.13 (3.2)	15000 (1034)
6MP6	1/2 NPT	SS-MMA-6MP6-NS8	2.06 (52.4)	0.87 (22.2)	0.13 (3.2)	15000 (1034)
6MP6	3/4 NPT	SS-MMA-6MP6-NS12	2.13 (54.0)	1.06 (27.0)	0.13 (3.2)	10000 (690)
6MP6	1 NPT	SS-MMA-6MP6-NS16	2.44 (61.9)	1.37 (34.9)	0.13 (3.2)	10000 (690)
6MP9	1/8 NPT	SS-MMA-6MP9-NS2	2.00 (50.8)	1.19 (30.2)	0.19 (4.8)	15000 (1034)
6MP9	1/4 NPT	SS-MMA-6MP9-NS4	2.13 (54.0)	1.19 (30.2)	0.19 (4.8)	15000 (1034)
6MP9	3/8 NPT	SS-MMA-6MP9-NS6	2.13 (54.0)	1.19 (30.2)	0.19 (4.8)	15000 (1034)
6MP9	1/2 NPT	SS-MMA-6MP9-NS8	2.37 (60.3)	1.19 (30.2)	0.19 (4.8)	15000 (1034)
6MP9	3/4 NPT	SS-MMA-6MP9-NS12	2.37 (60.3)	1.19 (30.2)	0.19 (4.8)	10000 (690)
6MP9	1 NPT	SS-MMA-6MP9-NS16	2.63 (66.7)	1.37 (34.9)	0.19 (4.8)	10000 (690)

60 Series Male to Male JIC

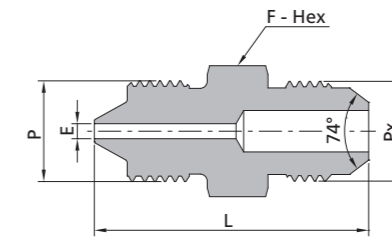

60 Series Male			Male JIC			
P-Connection Type	Px-Connection Type	Ordering Number	Dimension, in. (mm)			Working Pressure psig (bar)
			L	F	E	
6MP4	1/4 JIC	SS-MMA-6MP4-AN4	1.56 (39.7)	0.63 (15.9)	0.08 (2.1)	20000 (1379)
6MP4	3/8 JIC	SS-MMA-6MP4-AN6	1.56 (39.7)	0.63 (15.9)	0.08 (2.1)	20000 (1379)
6MP4	1/2 JIC	SS-MMA-6MP4-AN8	1.69 (42.9)	0.81 (20.6)	0.08 (2.1)	20000 (1379)
6MP4	5/8 JIC	SS-MMA-6MP4-AN10	1.81 (46.0)	0.94 (23.8)	0.08 (2.1)	20000 (1379)
6MP4	3/4 JIC	SS-MMA-6MP4-AN12	2.00 (50.8)	1.13 (28.6)	0.08 (2.1)	15000 (1034)
6MP4	1 JIC	SS-MMA-6MP4-AN16	2.13 (54.0)	1.37 (34.9)	0.08 (2.1)	15000 (1034)
6MP6	1/4 JIC	SS-MMA-6MP6-AN4	1.81 (46.0)	0.81 (20.6)	0.13 (3.2)	20000 (1379)
6MP6	3/8 JIC	SS-MMA-6MP6-AN6	1.81 (46.0)	0.81 (20.6)	0.13 (3.2)	20000 (1379)
6MP6	1/2 JIC	SS-MMA-6MP6-AN8	1.94 (49.2)	0.81 (20.6)	0.13 (3.2)	20000 (1379)
6MP6	5/8 JIC	SS-MMA-6MP6-AN10	2.06 (52.4)	0.94 (23.8)	0.13 (3.2)	20000 (1379)
6MP6	3/4 JIC	SS-MMA-6MP6-AN12	2.25 (57.2)	1.13 (28.6)	0.13 (3.2)	15000 (1034)
6MP6	1 JIC	SS-MMA-6MP6-AN16	2.37 (60.3)	1.37 (34.9)	0.13 (3.2)	15000 (1034)
6MP9	1/4 JIC	SS-MMA-6MP9-AN4	2.13 (54.0)	1.19 (30.2)	0.17 (4.4)	20000 (1379)
6MP9	3/8 JIC	SS-MMA-6MP9-AN6	2.13 (54.0)	1.19 (30.2)	0.19 (4.8)	20000 (1379)
6MP9	1/2 JIC	SS-MMA-6MP9-AN8	2.25 (57.2)	1.19 (30.2)	0.19 (4.8)	20000 (1379)
6MP9	5/8 JIC	SS-MMA-6MP9-AN10	2.37 (60.3)	1.19 (30.2)	0.19 (4.8)	20000 (1379)
6MP9	3/4 JIC	SS-MMA-6MP9-AN12	2.44 (61.9)	1.19 (30.2)	0.19 (4.8)	15000 (1034)
6MP9	1 JIC	SS-MMA-6MP9-AN16	2.56 (65.0)	1.37 (34.9)	0.19 (4.8)	15000 (1034)

60 Series Male to Type "M" Male

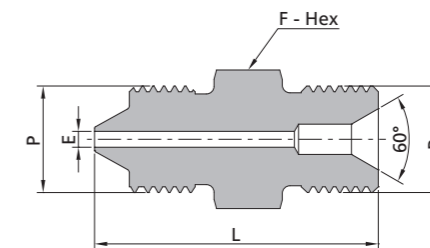

60 Series Male			Type "M" Male			
P-Connection Type	Px-Connection Type	Ordering Number	Dimension, in. (mm)			Working Pressure psig (bar)
			L	F	E	
6MP4	HM9	SS-MMA-6MP4-HM9	1.46 (37.1)	0.63 (15.9)	0.08 (2.1)	60000 (4137)
6MP4	HM12	SS-MMA-6MP4-HM12	1.63 (41.4)	0.75 (19.1)	0.08 (2.1)	30000 (2068)
6MP4	HM14	SS-MMA-6MP4-HM14	1.83 (46.6)	1.00 (25.4)	0.08 (2.1)	50000 (3447)
6MP4	HM16	SS-MMA-6MP4-HM16	1.72 (43.7)	1.00 (25.4)	0.08 (2.1)	30000 (2068)
6MP4	HM21	SS-MMA-6MP4-HM21	1.84 (46.7)	1.37 (34.9)	0.08 (2.1)	20000 (1379)
6MP6	HM9	SS-MMA-6MP6-HM9	1.77 (44.9)	0.81 (20.6)	0.09 (2.4)	60000 (4137)
6MP6	HM12	SS-MMA-6MP6-HM12	1.90 (48.2)	0.81 (20.6)	0.13 (3.2)	30000 (2068)



60 Series Male			Type "M" Male			
P-Connection Type	Px-Connection Type	Ordering Number	Dimension, in. (mm)			Working Pressure psig (bar)
			L	F	E	
6MP6	HM14	SS-MMA-6MP6-HM14	2.09 (53.0)	1.00 (25.4)	0.13 (3.2)	50000 (3447)
6MP6	HM16	SS-MMA-6MP6-HM16	1.97 (50.1)	1.00 (25.4)	0.13 (3.2)	30000 (2068)
6MP6	HM21	SS-MMA-6MP6-HM21	2.09 (53.1)	1.37 (34.9)	0.13 (3.2)	20000 (1379)
6MP9	HM9	SS-MMA-6MP9-HM9	2.07 (52.6)	1.19 (30.2)	0.09 (2.4)	60000 (4137)
6MP9	HM12	SS-MMA-6MP9-HM12	2.20 (55.9)	1.19 (30.2)	0.19 (4.8)	30000 (2068)
6MP9	HM14	SS-MMA-6MP9-HM14	2.33 (59.1)	1.19 (30.2)	0.15 (3.8)	50000 (3447)
6MP9	HM16	SS-MMA-6MP9-HM16	2.21 (56.2)	1.19 (30.2)	0.19 (4.8)	30000 (2068)
6MP9	HM21	SS-MMA-6MP9-HM21	2.26 (57.4)	1.37 (34.9)	0.19 (4.8)	20000 (1379)

Type "M" Male to 20 Series Coned and Threaded Nipples

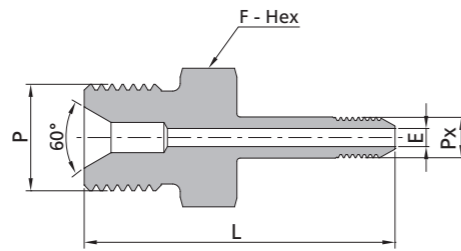

Type "M" Male			20 Series Coned and Threaded Nipples			
P-Connection Type	Px-Connection Type	Ordering Number	Dimension, in. (mm)			Working Pressure psig (bar)
			L	F	E	
HM9	2CT4	SS-MMA-HM9-2CT4	1.80 (45.7)	0.63 (15.9)	0.09 (2.4)	20000 (1379)
HM9	2CT6	SS-MMA-HM9-2CT6	2.05 (52.1)	0.63 (15.9)	0.09 (2.4)	20000 (1379)
HM9	2CT9	SS-MMA-HM9-2CT9	2.28 (58.0)	0.69 (17.5)	0.09 (2.4)	20000 (1379)
HM9	2CT12	SS-MMA-HM9-2CT12	2.58 (65.5)	0.87 (22.2)	0.09 (2.4)	20000 (1379)
HM9	2CT16	SS-MMA-HM9-2CT16	3.22 (81.7)	1.13 (28.6)	0.09 (2.4)	20000 (1379)
HM12	2CT4	SS-MMA-HM12-2CT4	1.97 (50.0)	0.75 (19.1)	0.11 (2.8)	20000 (1379)
HM12	2CT6	SS-MMA-HM12-2CT6	2.22 (56.4)	0.75 (19.1)	0.20 (5.2)	20000 (1379)
HM12	2CT9	SS-MMA-HM12-2CT9	2.43 (61.7)	0.75 (19.1)	0.29 (7.4)	20000 (1379)
HM12	2CT12	SS-MMA-HM12-2CT12	2.71 (68.8)	0.87 (22.2)	0.29 (7.4)	20000 (1379)
HM12	2CT16	SS-MMA-HM12-2CT16	3.35 (85.0)	1.13 (28.6)	0.29 (7.4)	20000 (1379)
HM14	2CT4	SS-MMA-HM14-2CT4	2.17 (55.2)	1.00 (25.4)	0.11 (2.8)	20000 (1379)
HM14	2CT6	SS-MMA-HM14-2CT6	2.43 (61.6)	1.00 (25.4)	0.15 (3.8)	20000 (1379)
HM14	2CT9	SS-MMA-HM14-2CT9	2.63 (66.9)	1.00 (25.4)	0.15 (3.8)	20000 (1379)
HM14	2CT12	SS-MMA-HM14-2CT12	2.88 (73.2)	1.00 (25.4)	0.15 (3.8)	20000 (1379)
HM14	2CT16	SS-MMA-HM14-2CT16	3.47 (88.2)	1.13 (28.6)	0.15 (3.8)	20000 (1379)
HM16	2CT4	SS-MMA-HM16-2CT4	2.06 (52.3)	1.00 (25.4)	0.11 (2.8)	20000 (1379)
HM16	2CT6	SS-MMA-HM16-2CT6	2.31 (58.7)	1.00 (25.4)	0.20 (5.2)	20000 (1379)
HM16	2CT9	SS-MMA-HM16-2CT9	2.52 (64.0)	1.00 (25.4)	0.31 (7.9)	20000 (1379)
HM16	2CT12	SS-MMA-HM16-2CT12	2.77 (70.3)	1.00 (25.4)	0.39 (10.0)	20000 (1379)
HM16	2CT16	SS-MMA-HM16-2CT16	3.36 (85.3)	1.13 (28.6)	0.39 (10.0)	20000 (1379)
HM21	2CT4	SS-MMA-HM21-2CT4	2.18 (55.3)	1.37 (34.9)	0.11 (2.8)	20000 (1379)
HM21	2CT6	SS-MMA-HM21-2CT6	2.43 (61.7)	1.37 (34.9)	0.20 (5.2)	20000 (1379)
HM21	2CT9	SS-MMA-HM21-2CT9	2.64 (67.0)	1.37 (34.9)	0.31 (7.9)	20000 (1379)
HM21	2CT12	SS-MMA-HM21-2CT12	2.89 (73.3)	1.37 (34.9)	0.44 (11.1)	20000 (1379)
HM21	2CT16	SS-MMA-HM21-2CT16	3.42 (86.9)	1.37 (34.9)	0.56 (14.3)	20000 (1379)

Type "M" Male to 60 Series Coned and Threaded Nipples

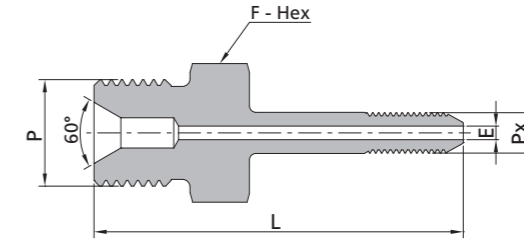

Type "M" Male			60 Series Coned and Threaded Nipples			
P-Connection Type	Px-Connection Type	Ordering Number	Dimension, in. (mm)			Working Pressure psig (bar)
			L	F	E	
HM9	6CT4	SS-MMA-HM9-6CT4	2.15 (54.6)	0.63 (15.9)	0.08 (2.1)	60000 (4137)
HM9	6CT6	SS-MMA-HM9-6CT6	2.53 (64.3)	0.63 (15.9)	0.09 (2.4)	60000 (4137)
HM9	6CT9	SS-MMA-HM9-6CT9	3.12 (79.3)	0.63 (15.9)	0.09 (2.4)	60000 (4137)
HM12	6CT4	SS-MMA-HM12-6CT4	2.31 (58.6)	0.75 (19.1)	0.08 (2.1)	30000 (2068)
HM12	6CT6	SS-MMA-HM12-6CT6	2.70 (68.6)	0.75 (19.1)	0.13 (3.2)	30000 (2068)
HM12	6CT9	SS-MMA-HM12-6CT9	3.29 (83.6)	0.75 (19.1)	0.19 (4.8)	30000 (2068)
HM14	6CT4	SS-MMA-HM14-6CT4	2.51 (63.8)	1.00 (25.4)	0.08 (2.1)	50000 (3447)
HM14	6CT6	SS-MMA-HM14-6CT6	2.91 (73.8)	1.00 (25.4)	0.13 (3.2)	50000 (3447)
HM14	6CT9	SS-MMA-HM14-6CT9	3.50 (88.8)	1.00 (25.4)	0.15 (3.8)	50000 (3447)
HM16	6CT4	SS-MMA-HM16-6CT4	2.40 (60.9)	1.00 (25.4)	0.08 (2.1)	30000 (2068)
HM16	6CT6	SS-MMA-HM16-6CT6	2.79 (70.9)	1.00 (25.4)	0.13 (3.2)	30000 (2068)
HM16	6CT9	SS-MMA-HM16-6CT9	3.38 (85.9)	1.00 (25.4)	0.19 (4.8)	30000 (2068)
HM21	6CT4	SS-MMA-HM21-6CT4	2.52 (63.9)	1.37 (34.9)	0.08 (2.1)	20000 (1379)
HM21	6CT6	SS-MMA-HM21-6CT6	2.91 (73.9)	1.37 (34.9)	0.13 (3.2)	20000 (1379)
HM21	6CT9	SS-MMA-HM21-6CT9	3.50 (88.9)	1.37 (34.9)	0.19 (4.8)	20000 (1379)

20 Series Female to 15 Series Female

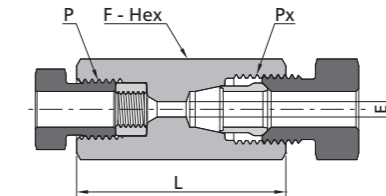

20 Series Female			15 Series Female			
P-Connection Type	Px-Connection Type	Ordering Number	Dimension, in. (mm)			Working Pressure psig (bar)
			L	F	E	
2FH4	FH2	SS-FFC-2FH4-FH2	1.25 (31.8)	0.63 (15.9)	0.09 (2.4)	15000 (1034)
2FH4	FH4	SS-FFC-2FH4-FH4	1.50 (38.1)	0.63 (15.9)	0.11 (2.8)	15000 (1034)
2FH4	FH6	SS-FFC-2FH4-FH6	1.63 (41.3)	0.75 (19.1)	0.11 (2.8)	15000 (1034)
2FH4	FH8	SS-FFC-2FH4-FH8	1.75 (44.5)	1.00 (25.4)	0.11 (2.8)	15000 (1034)
2FH6	FH2	SS-FFC-2FH6-FH2	1.44 (36.5)	0.75 (19.1)	0.09 (2.4)	15000 (1034)
2FH6	FH4	SS-FFC-2FH6-FH4	1.69 (42.9)	0.75 (19.1)	0.19 (4.8)	15000 (1034)
2FH6	FH6	SS-FFC-2FH6-FH6	1.75 (44.5)	0.75 (19.1)	0.20 (5.2)	15000 (1034)
2FH6	FH8	SS-FFC-2FH6-FH8	1.87 (47.6)	1.00 (25.4)	0.20 (5.2)	15000 (1034)

20 Series Female			15 Series Female			
P-Connection Type	Px-Connection Type	Ordering Number	Dimension, in. (mm)			Working Pressure psig (bar)
			L	F	E	
2FH9	FH2	SS-FFC-2FH9-FH2	1.69 (42.9)	1.00 (25.4)	0.09 (2.4)	15000 (1034)
2FH9	FH4	SS-FFC-2FH9-FH4	1.87 (47.6)	1.00 (25.4)	0.19 (4.8)	15000 (1034)
2FH9	FH6	SS-FFC-2FH9-FH6	1.94 (49.2)	1.00 (25.4)	0.25 (6.4)	15000 (1034)
2FH9	FH8	SS-FFC-2FH9-FH8	2.06 (52.4)	1.00 (25.4)	0.31 (7.9)	15000 (1034)
2FH12	FH6	SS-FFC-2FH12-FH6	2.25 (57.2)	1.37 (34.9)	0.25 (6.4)	15000 (1034)
2FH12	FH8	SS-FFC-2FH12-FH8	2.25 (57.2)	1.37 (34.9)	0.37 (9.5)	15000 (1034)
2FH16	FH8	SS-FFC-2FH16-FH8	2.81 (71.4)	1.75 (44.5)	0.37 (9.5)	15000 (1034)

20 Series Female to Female NPT Thread

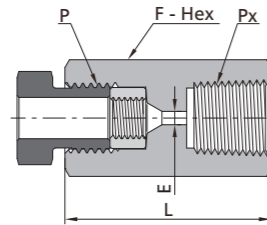

20 Series Female			Female NPT Threads			
P-Connection Type	Px-Connection Type	Ordering Number	Dimensions, in. (mm)			Working Pressure psig (bar)
			L	F	E	
2FH4	1/8 NPT	SS-FFC-2FH4-NS2	1.37 (34.9)	0.63 (15.9)	0.11 (2.8)	15000 (1034)
2FH4	1/4 NPT	SS-FFC-2FH4-NS4	1.63 (41.3)	0.94 (23.8)	0.11 (2.8)	15000 (1034)
2FH4	3/8 NPT	SS-FFC-2FH4-NS6	1.63 (41.3)	1.13 (28.6)	0.11 (2.8)	15000 (1034)
2FH4	1/2 NPT	SS-FFC-2FH4-NS8	2.00 (50.8)	1.37 (34.9)	0.11 (2.8)	15000 (1034)
2FH6	1/8 NPT	SS-FFC-2FH6-NS2	1.50 (38.1)	0.75 (19.1)	0.20 (5.1)	15000 (1034)
2FH6	1/4 NPT	SS-FFC-2FH6-NS4	1.75 (44.5)	0.94 (23.8)	0.20 (5.1)	15000 (1034)
2FH6	3/8 NPT	SS-FFC-2FH6-NS6	1.81 (46.0)	1.13 (28.6)	0.20 (5.1)	15000 (1034)
2FH6	1/2 NPT	SS-FFC-2FH6-NS8	2.13 (54.0)	1.37 (34.9)	0.20 (5.1)	15000 (1034)
2FH6	3/4 NPT	SS-FFC-2FH6-NS12	2.25 (57.2)	1.50 (38.1)	0.20 (5.1)	10000 (690)
2FH9	1/8 NPT	SS-FFC-2FH9-NS2	1.63 (41.3)	1.00 (25.4)	0.31 (7.9)	15000 (1034)
2FH9	1/4 NPT	SS-FFC-2FH9-NS4	2.00 (50.8)	1.00 (25.4)	0.31 (7.9)	15000 (1034)
2FH9	3/8 NPT	SS-FFC-2FH9-NS6	2.00 (50.8)	1.13 (28.6)	0.31 (7.9)	15000 (1034)
2FH9	1/2 NPT	SS-FFC-2FH9-NS8	2.25 (57.2)	1.37 (34.9)	0.31 (7.9)	15000 (1034)
2FH9	3/4 NPT	SS-FFC-2FH9-NS12	2.25 (57.2)	1.50 (38.1)	0.31 (7.9)	10000 (690)
2FH9	1 NPT	SS-FFC-2FH9-NS16	2.63 (66.7)	1.75 (44.5)	0.31 (7.9)	10000 (690)
2FH12	1/8 NPT	SS-FFC-2FH12-NS2	1.75 (44.5)	1.37 (34.9)	0.32 (8.1)	15000 (1034)
2FH12	1/4 NPT	SS-FFC-2FH12-NS4	2.00 (50.8)	1.37 (34.9)	0.41 (10.4)	15000 (1034)
2FH12	3/8 NPT	SS-FFC-2FH12-NS6	2.37 (60.3)	1.37 (34.9)	0.44 (11.1)	15000 (1034)
2FH12	1/2 NPT	SS-FFC-2FH12-NS8	2.63 (66.7)	1.37 (34.9)	0.44 (11.1)	15000 (1034)
2FH12	3/4 NPT	SS-FFC-2FH12-NS12	2.63 (66.7)	1.50 (38.1)	0.44 (11.1)	10000 (690)
2FH12	1 NPT	SS-FFC-2FH12-NS16	2.63 (66.7)	1.75 (44.5)	0.44 (11.1)	10000 (690)
2FH16	1/4 NPT	SS-FFC-2FH16-NS4	2.37 (60.3)	1.75 (44.5)	0.41 (10.4)	15000 (1034)
2FH16	3/8 NPT	SS-FFC-2FH16-NS6	2.50 (63.5)	1.75 (44.5)	0.55 (13.9)	15000 (1034)
2FH16	1/2 NPT	SS-FFC-2FH16-NS8	3.00 (76.2)	1.75 (44.5)	0.56 (14.3)	15000 (1034)
2FH16	3/4 NPT	SS-FFC-2FH16-NS12	3.00 (76.2)	1.75 (44.5)	0.56 (14.3)	10000 (690)
2FH16	1 NPT	SS-FFC-2FH16-NS16	3.00 (76.2)	1.75 (44.5)	0.56 (14.3)	10000 (690)

60 Series Female to 15 Series Female

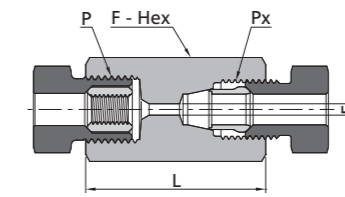

60 Series Female			15 Series Female			Working Pressure psig (bar)
P-Connection Type	Px-Connection Type	Ordering Number	Dimension, in. (mm)			
			L	F	E	
6FH4	FH2	SS-FFC-6FH4-FH2	1.19 (30.2)	0.75 (19.1)	0.09 (2.4)	15000 (1034)
6FH4	FH4	SS-FFC-6FH4-FH4	1.50 (38.1)	0.75 (19.1)	0.09 (2.4)	15000 (1034)
6FH4	FH6	SS-FFC-6FH4-FH6	1.63 (41.3)	0.75 (19.1)	0.09 (2.4)	15000 (1034)
6FH4	FH8	SS-FFC-6FH4-FH8	1.75 (44.5)	1.00 (25.4)	0.09 (2.4)	15000 (1034)
6FH6	FH2	SS-FFC-6FH6-FH2	1.50 (38.1)	1.00 (25.4)	0.09 (2.4)	15000 (1034)
6FH6	FH4	SS-FFC-6FH6-FH4	1.75 (44.5)	1.00 (25.4)	0.13 (3.2)	15000 (1034)
6FH6	FH6	SS-FFC-6FH6-FH6	1.81 (46.0)	1.00 (25.4)	0.13 (3.2)	15000 (1034)
6FH6	FH8	SS-FFC-6FH6-FH8	2.00 (50.8)	1.00 (25.4)	0.13 (3.2)	15000 (1034)
6FH9	FH2	SS-FFC-6FH9-FH2	1.69 (42.9)	1.37 (34.9)	0.09 (2.4)	15000 (1034)
6FH9	FH4	SS-FFC-6FH9-FH4	1.87 (47.6)	1.37 (34.9)	0.19 (4.8)	15000 (1034)
6FH9	FH6	SS-FFC-6FH9-FH6	2.00 (50.8)	1.37 (34.9)	0.19 (4.8)	15000 (1034)
6FH9	FH8	SS-FFC-6FH9-FH8	2.13 (54.0)	1.37 (34.9)	0.19 (4.8)	15000 (1034)

60 Series Female to 20 Series Female

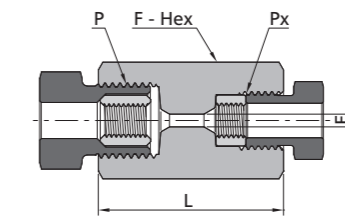

60 Series Female			20 Series Female			Working Pressure psig (bar)
P-Connection Type	Px-Connection Type	Ordering Number	Dimension, in. (mm)			
			L	F	E	
6FH4	2FH4	SS-FFC-6FH4-2FH4	1.37 (34.9)	0.75 (19.1)	0.09 (2.4)	20000 (1379)
6FH4	2FH6	SS-FFC-6FH4-2FH6	1.56 (39.7)	0.75 (19.1)	0.09 (2.4)	20000 (1379)
6FH4	2FH9	SS-FFC-6FH4-2FH9	1.81 (46.0)	1.00 (25.4)	0.09 (2.4)	20000 (1379)
6FH4	2FH12	SS-FFC-6FH4-2FH12	2.06 (52.4)	1.37 (34.9)	0.09 (2.4)	20000 (1379)
6FH4	2FH16	SS-FFC-6FH4-2FH16	2.56 (65.1)	1.75 (44.5)	0.09 (2.4)	20000 (1379)
6FH6	2FH4	SS-FFC-6FH6-2FH4	1.63 (41.3)	1.00 (25.4)	0.11 (2.8)	20000 (1379)
6FH6	2FH6	SS-FFC-6FH6-2FH6	1.81 (46.0)	1.00 (25.4)	0.13 (3.2)	20000 (1379)
6FH6	2FH9	SS-FFC-6FH6-2FH9	2.06 (52.4)	1.00 (25.4)	0.13 (3.2)	20000 (1379)
6FH6	2FH12	SS-FFC-6FH6-2FH12	2.31 (58.7)	1.37 (34.9)	0.13 (3.2)	20000 (1379)
6FH6	2FH16	SS-FFC-6FH6-2FH16	2.81 (71.4)	1.75 (44.5)	0.13 (3.2)	20000 (1379)
6FH9	2FH4	SS-FFC-6FH9-2FH4	1.81 (46.0)	1.37 (34.9)	0.11 (2.8)	20000 (1379)
6FH9	2FH6	SS-FFC-6FH9-2FH6	1.94 (49.2)	1.37 (34.9)	0.19 (4.8)	20000 (1379)
6FH9	2FH9	SS-FFC-6FH9-2FH9	2.25 (57.2)	1.37 (34.9)	0.19 (4.8)	20000 (1379)
6FH9	2FH12	SS-FFC-6FH9-2FH12	2.44 (61.9)	1.37 (34.9)	0.19 (4.8)	20000 (1379)
6FH9	2FH16	SS-FFC-6FH9-2FH16	3.00 (76.2)	1.75 (44.5)	0.19 (4.8)	20000 (1379)

60 Series Female to Female NPT Thread

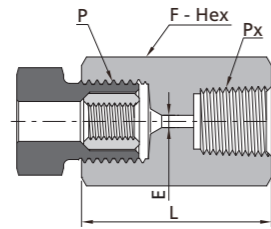

60 Series Female			Female NPT Threads			
P-Connection Type	Px-Connection Type	Ordering Number	Dimensions, in. (mm)			Working Pressure psig (bar)
			L	F	E	
6FH4	1/8 NPT	SS-FFC-6FH4-NS2	1.37 (34.9)	0.75 (19.1)	0.09 (2.4)	15000 (1034)
6FH4	1/4 NPT	SS-FFC-6FH4-NS4	1.63 (41.3)	0.94 (23.8)	0.09 (2.4)	15000 (1034)
6FH4	3/8 NPT	SS-FFC-6FH4-NS6	1.63 (41.3)	1.13 (28.6)	0.09 (2.4)	15000 (1034)
6FH4	1/2 NPT	SS-FFC-6FH4-NS8	2.00 (50.8)	1.37 (34.9)	0.09 (2.4)	15000 (1034)
6FH4	3/4 NPT	SS-FFC-6FH4-NS12	2.00 (50.8)	1.50 (38.1)	0.09 (2.4)	10000 (690)
6FH4	1 NPT	SS-FFC-6FH4-NS16	2.37 (60.3)	1.75 (44.5)	0.09 (2.4)	10000 (690)
6FH6	1/8 NPT	SS-FFC-6FH6-NS2	1.63 (41.3)	1.00 (25.4)	0.13 (3.2)	15000 (1034)
6FH6	1/4 NPT	SS-FFC-6FH6-NS4	1.87 (47.6)	1.00 (25.4)	0.13 (3.2)	15000 (1034)
6FH6	3/8 NPT	SS-FFC-6FH6-NS6	1.87 (47.6)	1.13 (28.6)	0.13 (3.2)	15000 (1034)
6FH6	1/2 NPT	SS-FFC-6FH6-NS8	2.13 (54.0)	1.37 (34.9)	0.13 (3.2)	15000 (1034)
6FH6	3/4 NPT	SS-FFC-6FH6-NS12	2.13 (54.0)	1.50 (38.1)	0.13 (3.2)	10000 (690)
6FH6	1 NPT	SS-FFC-6FH6-NS16	2.25 (57.2)	1.75 (44.5)	0.13 (3.2)	10000 (690)
6FH9	1/8 NPT	SS-FFC-6FH9-NS2	1.81 (46.0)	1.37 (34.9)	0.19 (4.8)	15000 (1034)
6FH9	1/4 NPT	SS-FFC-6FH9-NS4	2.00 (50.8)	1.37 (34.9)	0.19 (4.8)	15000 (1034)
6FH9	3/8 NPT	SS-FFC-6FH9-NS6	2.00 (50.8)	1.37 (34.9)	0.19 (4.8)	15000 (1034)
6FH9	1/2 NPT	SS-FFC-6FH9-NS8	2.37 (60.3)	1.37 (34.9)	0.19 (4.8)	15000 (1034)
6FH9	3/4 NPT	SS-FFC-6FH9-NS12	2.37 (60.3)	1.50 (38.1)	0.19 (4.8)	10000 (690)
6FH9	1 NPT	SS-FFC-6FH9-NS16	2.50 (63.5)	1.75 (44.5)	0.19 (4.8)	10000 (690)

15 Series Female to 15 Series Male

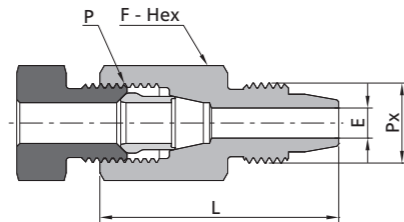

15 Series Female			15 Series Male			
P-Connection Type	Px-Connection Type	Ordering Number	Dimension, in. (mm)			Working Pressure psig (bar)
			L	F	E	
FH2	MP2	SS-FMA-FH2-MP2	1.06 (27.0)	0.50 (12.7)	0.09 (2.4)	15000 (1034)
FH2	MP4	SS-FMA-FH2-MP4	1.13 (28.6)	0.63 (15.9)	0.09 (2.4)	15000 (1034)
FH2	MP6	SS-FMA-FH2-MP6	1.13 (28.6)	0.75 (19.1)	0.09 (2.4)	15000 (1034)
FH2	MP8	SS-FMA-FH2-MP8	1.31 (33.3)	0.94 (23.8)	0.09 (2.4)	15000 (1034)

15 Series Female			15 Series Male			
P-Connection Type	Px-Connection Type	Ordering Number	Dimension, in. (mm)			Working Pressure psig (bar)
			L	F	E	
FH4	MP2	SS-FMA-FH4-MP2	1.44 (36.5)	0.63 (15.9)	0.09 (2.4)	15000 (1034)
FH4	MP4	SS-FMA-FH4-MP4	1.50 (38.1)	0.63 (15.9)	0.19 (4.8)	15000 (1034)
FH4	MP6	SS-FMA-FH4-MP6	1.50 (38.1)	0.75 (19.1)	0.19 (4.8)	15000 (1034)
FH4	MP8	SS-FMA-FH4-MP8	1.50 (38.1)	0.94 (23.8)	0.19 (4.8)	15000 (1034)
FH6	MP2	SS-FMA-FH6-MP2	1.56 (39.7)	0.75 (19.1)	0.09 (2.4)	15000 (1034)
FH6	MP4	SS-FMA-FH6-MP4	1.69 (42.9)	0.75 (19.1)	0.19 (4.8)	15000 (1034)
FH6	MP6	SS-FMA-FH6-MP6	1.69 (42.9)	0.75 (19.1)	0.25 (6.4)	15000 (1034)
FH6	MP8	SS-FMA-FH6-MP8	1.63 (41.3)	0.94 (23.8)	0.25 (6.4)	15000 (1034)
FH8	MP2	SS-FMA-FH8-MP2	1.63 (41.3)	1.00 (25.4)	0.09 (2.4)	15000 (1034)
FH8	MP4	SS-FMA-FH8-MP4	1.75 (44.5)	1.00 (25.4)	0.19 (4.8)	15000 (1034)
FH8	MP6	SS-FMA-FH8-MP6	1.81 (46.0)	1.00 (25.4)	0.25 (6.4)	15000 (1034)
FH8	MP8	SS-FMA-FH8-MP8	1.81 (46.0)	1.00 (25.4)	0.37 (9.5)	15000 (1034)

15 Series Female to 20 Series Male

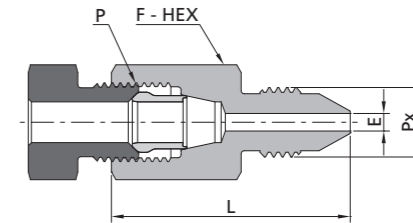

15 Series Female			20 Series Male			
P-Connection Type	Px-Connection Type	Ordering Number	Dimension, in. (mm)			Working Pressure psig (bar)
			L	F	E	
FH2	2MP4	SS-FMA-FH2-2MP4	1.19 (30.2)	0.50 (12.7)	0.09 (2.4)	15000 (1034)
FH2	2MP6	SS-FMA-FH2-2MP6	1.25 (31.8)	0.63 (15.9)	0.09 (2.4)	15000 (1034)
FH2	2MP9	SS-FMA-FH2-2MP9	1.50 (38.1)	0.94 (23.8)	0.09 (2.4)	15000 (1034)
FH2	2MP12	SS-FMA-FH2-2MP12	1.75 (44.5)	1.19 (30.2)	0.09 (2.4)	15000 (1034)
FH2	2MP16	SS-FMA-FH2-2MP16	2.37 (60.3)	1.50 (38.1)	0.09 (2.4)	15000 (1034)
FH4	2MP4	SS-FMA-FH4-2MP4	1.50 (38.1)	0.63 (15.9)	0.11 (2.8)	15000 (1034)
FH4	2MP6	SS-FMA-FH4-2MP6	1.63 (41.3)	0.63 (15.9)	0.19 (4.8)	15000 (1034)
FH4	2MP9	SS-FMA-FH4-2MP9	1.56 (39.7)	0.94 (23.8)	0.19 (4.8)	15000 (1034)
FH4	2MP12	SS-FMA-FH4-2MP12	1.75 (44.5)	1.19 (30.2)	0.19 (4.8)	15000 (1034)
FH4	2MP16	SS-FMA-FH4-2MP16	2.37 (60.3)	1.50 (38.1)	0.19 (4.8)	15000 (1034)
FH6	2MP4	SS-FMA-FH6-2MP4	1.69 (42.9)	0.75 (19.1)	0.11 (2.8)	15000 (1034)
FH6	2MP6	SS-FMA-FH6-2MP6	1.75 (44.5)	0.75 (19.1)	0.20 (5.2)	15000 (1034)
FH6	2MP9	SS-FMA-FH6-2MP9	1.81 (46.0)	0.94 (23.8)	0.25 (6.4)	15000 (1034)
FH6	2MP12	SS-FMA-FH6-2MP12	1.87 (47.6)	1.19 (30.2)	0.25 (6.4)	15000 (1034)
FH6	2MP16	SS-FMA-FH6-2MP16	2.37 (60.3)	1.50 (38.1)	0.25 (6.4)	15000 (1034)
FH8	2MP4	SS-FMA-FH8-2MP4	1.75 (44.5)	1.00 (25.4)	0.11 (2.8)	15000 (1034)
FH8	2MP6	SS-FMA-FH8-2MP6	1.94 (49.2)	1.00 (25.4)	0.20 (5.2)	15000 (1034)
FH8	2MP9	SS-FMA-FH8-2MP9	2.06 (52.4)	1.00 (25.4)	0.31 (7.9)	15000 (1034)
FH8	2MP12	SS-FMA-FH8-2MP12	2.06 (52.4)	1.19 (30.2)	0.37 (9.5)	15000 (1034)
FH8	2MP16	SS-FMA-FH8-2MP16	2.50 (63.5)	1.50 (38.1)	0.37 (9.5)	15000 (1034)

15 Series Female to 20 Series Coned and Threaded Nipples

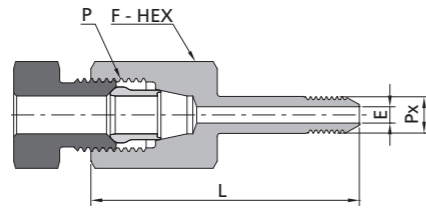

15 Series Female			20 Series Coned and Threaded Nipples			
P-Connection Type	Px-Connection Type	Ordering Number	Dimension, in. (mm)			Working Pressure psig (bar)
			L	F	E	
FH2	2CT4	SS-FMA-FH2-2CT4	1.50 (38.1)	0.50 (12.7)	0.09 (2.4)	15000 (1034)
FH2	2CT6	SS-FMA-FH2-2CT6	1.75 (44.5)	0.50 (12.7)	0.09 (2.4)	15000 (1034)
FH2	2CT9	SS-FMA-FH2-2CT9	1.94 (49.2)	0.69 (17.5)	0.09 (2.4)	15000 (1034)
FH2	2CT12	SS-FMA-FH2-2CT12	2.13 (54.0)	0.87 (22.2)	0.09 (2.4)	15000 (1034)
FH4	2CT4	SS-FMA-FH4-2CT4	1.81 (46.0)	0.63 (15.9)	0.11 (2.8)	15000 (1034)
FH4	2CT6	SS-FMA-FH4-2CT6	2.00 (50.8)	0.63 (15.9)	0.19 (4.8)	15000 (1034)
FH4	2CT9	SS-FMA-FH4-2CT9	2.19 (55.6)	0.69 (17.5)	0.19 (4.8)	15000 (1034)
FH4	2CT12	SS-FMA-FH4-2CT12	2.37 (60.3)	0.87 (22.2)	0.19 (4.8)	15000 (1034)
FH6	2CT4	SS-FMA-FH6-2CT4	2.00 (50.8)	0.75 (19.1)	0.11 (2.8)	15000 (1034)
FH6	2CT6	SS-FMA-FH6-2CT6	2.31 (58.7)	0.75 (19.1)	0.20 (5.2)	15000 (1034)
FH6	2CT9	SS-FMA-FH6-2CT9	2.37 (60.3)	0.75 (19.1)	0.25 (6.4)	15000 (1034)
FH6	2CT12	SS-FMA-FH6-2CT12	2.50 (63.5)	0.87 (22.2)	0.25 (6.4)	15000 (1034)
FH6	2CT16	SS-FMA-FH6-2CT16	3.00 (76.2)	1.13 (28.6)	0.25 (6.4)	15000 (1034)
FH8	2CT4	SS-FMA-FH8-2CT4	2.06 (52.4)	1.00 (25.4)	0.11 (2.8)	15000 (1034)
FH8	2CT6	SS-FMA-FH8-2CT6	2.31 (58.7)	1.00 (25.4)	0.20 (5.2)	15000 (1034)
FH8	2CT9	SS-FMA-FH8-2CT9	2.56 (65.1)	1.00 (25.4)	0.31 (7.9)	15000 (1034)
FH8	2CT12	SS-FMA-FH8-2CT12	2.63 (66.7)	1.00 (25.4)	0.37 (9.5)	15000 (1034)
FH8	2CT16	SS-FMA-FH8-2CT16	3.19 (81.0)	1.13 (28.6)	0.37 (9.5)	15000 (1034)

15 Series Female to 60 Series Male

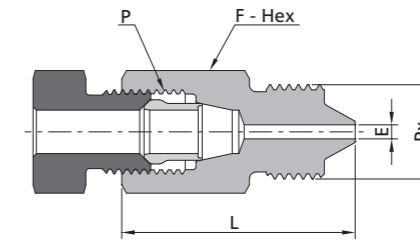

15 Series Female			60 Series Male			Working Pressure psig (bar)
P-Connection Type	Px-Connection Type	Ordering Number	Dimension, in. (mm)			
			L	F	E	
FH2	6MP4	SS-FMA-FH2-6MP4	1.06 (27.0)	0.63 (15.9)	0.08 (2.1)	15000 (1034)
FH2	6MP6	SS-FMA-FH2-6MP6	1.31 (33.3)	0.81 (20.6)	0.09 (2.4)	15000 (1034)
FH2	6MP9	SS-FMA-FH2-6MP9	1.63 (41.3)	1.19 (30.2)	0.09 (2.4)	15000 (1034)
FH4	6MP4	SS-FMA-FH4-6MP4	1.37 (34.9)	0.63 (15.9)	0.08 (2.1)	15000 (1034)
FH4	6MP6	SS-FMA-FH4-6MP6	1.56 (39.7)	0.81 (20.6)	0.13 (3.2)	15000 (1034)
FH4	6MP9	SS-FMA-FH4-6MP9	1.63 (41.3)	1.19 (30.2)	0.19 (4.8)	15000 (1034)
FH6	6MP4	SS-FMA-FH6-6MP4	1.56 (39.7)	0.75 (19.1)	0.08 (2.1)	15000 (1034)
FH6	6MP6	SS-FMA-FH6-6MP6	1.75 (44.5)	0.81 (20.6)	0.13 (3.2)	15000 (1034)
FH6	6MP9	SS-FMA-FH6-6MP9	1.63 (41.3)	1.19 (30.2)	0.19 (4.8)	15000 (1034)
FH8	6MP4	SS-FMA-FH8-6MP4	1.69 (42.9)	1.00 (25.4)	0.08 (2.1)	15000 (1034)
FH8	6MP6	SS-FMA-FH8-6MP6	1.87 (47.6)	1.00 (25.4)	0.13 (3.2)	15000 (1034)
FH8	6MP9	SS-FMA-FH8-6MP9	1.87 (47.6)	1.19 (30.2)	0.19 (4.8)	15000 (1034)

15 Series Female to 60 Series Coned and Threaded Nipples

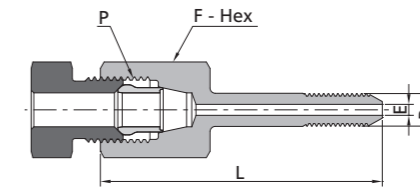

15 Series Female			60 Series Coned and Threaded Nipples			Working Pressure psig (bar)
P-Connection Type	Px-Connection Type	Ordering Number	Dimension, in. (mm)			
			L	F	E	
FH2	6CT4	SS-FMA-FH2-6CT4	1.87 (47.6)	0.50 (12.7)	0.08 (2.1)	15000 (1034)
FH2	6CT6	SS-FMA-FH2-6CT6	2.25 (57.2)	0.50 (12.7)	0.09 (2.4)	15000 (1034)
FH4	6CT4	SS-FMA-FH4-6CT4	2.13 (54.0)	0.63 (15.9)	0.08 (2.1)	15000 (1034)
FH4	6CT6	SS-FMA-FH4-6CT6	2.50 (63.5)	0.63 (15.9)	0.13 (3.2)	15000 (1034)
FH4	6CT9	SS-FMA-FH4-6CT9	3.00 (76.2)	0.63 (15.9)	0.19 (4.8)	15000 (1034)
FH6	6CT4	SS-FMA-FH6-6CT4	2.37 (60.3)	0.75 (19.1)	0.08 (2.1)	15000 (1034)
FH6	6CT6	SS-FMA-FH6-6CT6	2.69 (68.3)	0.75 (19.1)	0.13 (3.2)	15000 (1034)
FH6	6CT9	SS-FMA-FH6-6CT9	3.19 (81.0)	0.75 (19.1)	0.19 (4.8)	15000 (1034)
FH8	6CT4	SS-FMA-FH8-6CT4	2.44 (61.9)	1.00 (25.4)	0.08 (2.1)	15000 (1034)
FH8	6CT6	SS-FMA-FH8-6CT6	2.75 (69.9)	1.00 (25.4)	0.13 (3.2)	15000 (1034)
FH8	6CT9	SS-FMA-FH8-6CT9	3.38 (85.8)	1.00 (25.4)	0.19 (4.8)	15000 (1034)



15 Series Female to Type "M" Male

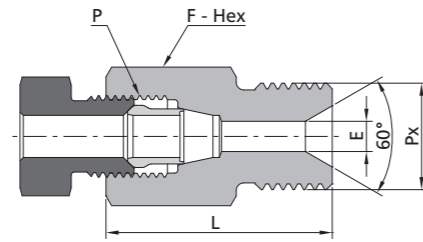

15 Series Female			Type "M" Male			
P-Connection Type	Px-Connection Type	Ordering Number	Dimension, in. (mm)			Working Pressure psig (bar)
			L	F	E	
FH2	HM9	SS-FMA-FH2-HM9	1.06 (27.0)	0.63 (15.9)	0.09 (2.4)	15000 (1034)
FH2	HM12	SS-FMA-FH2-HM12	1.13 (28.6)	0.75 (19.1)	0.09 (2.4)	15000 (1034)
FH4	HM9	SS-FMA-FH4-HM9	1.37 (34.9)	0.63 (15.9)	0.09 (2.4)	15000 (1034)
FH4	HM12	SS-FMA-FH4-HM12	1.44 (36.5)	0.75 (19.1)	0.19 (4.8)	15000 (1034)
FH4	HM14	SS-FMA-FH4-HM14	1.63 (41.3)	1.00 (25.4)	0.15 (3.8)	15000 (1034)
FH6	HM9	SS-FMA-FH6-HM9	1.50 (38.1)	0.75 (19.1)	0.09 (2.4)	15000 (1034)
FH6	HM12	SS-FMA-FH6-HM12	1.63 (41.3)	0.75 (19.1)	0.25 (6.4)	15000 (1034)
FH6	HM14	SS-FMA-FH6-HM14	1.75 (44.5)	1.00 (25.4)	0.15 (3.8)	15000 (1034)
FH6	HM16	SS-FMA-FH6-HM16	1.63 (41.3)	1.00 (25.4)	0.25 (6.4)	15000 (1034)
FH8	HM9	SS-FMA-FH8-HM9	1.63 (41.3)	1.00 (25.4)	0.09 (2.4)	15000 (1034)
FH8	HM12	SS-FMA-FH8-HM12	1.63 (41.3)	1.00 (25.4)	0.29 (7.4)	15000 (1034)
FH8	HM14	SS-FMA-FH8-HM14	1.81 (46.1)	1.00 (25.4)	0.15 (3.8)	15000 (1034)
FH8	HM16	SS-FMA-FH8-HM16	1.75 (44.5)	1.00 (25.4)	0.37 (9.5)	15000 (1034)
FH8	HM21	SS-FMA-FH8-HM21	1.75 (44.5)	1.37 (34.9)	0.37 (9.5)	15000 (1034)

20 Series Female to 15 Series Male

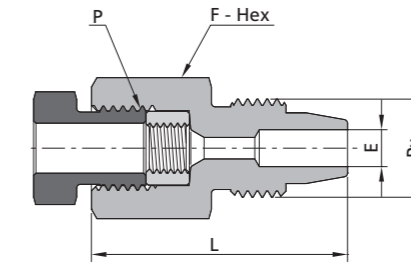

20 Series Female			15 Series Male			
P-Connection Type	Px-Connection Type	Ordering Number	Dimension, in. (mm)			Working Pressure psig (bar)
			L	F	E	
2FH4	MP2	SS-FMA-2FH4-MP2	1.19 (30.2)	0.63 (15.9)	0.09 (2.4)	15000 (1034)
2FH4	MP4	SS-FMA-2FH4-MP4	1.31 (33.3)	0.63 (15.9)	0.11 (2.8)	15000 (1034)
2FH4	MP6	SS-FMA-2FH4-MP6	1.37 (34.9)	0.75 (19.1)	0.11 (2.8)	15000 (1034)
2FH4	MP8	SS-FMA-2FH4-MP8	1.31 (33.3)	0.94 (23.8)	0.11 (2.8)	15000 (1034)
2FH6	MP2	SS-FMA-2FH6-MP2	1.50 (38.1)	0.75 (19.1)	0.09 (2.4)	15000 (1034)
2FH6	MP4	SS-FMA-2FH6-MP4	1.50 (38.1)	0.75 (19.1)	0.19 (4.8)	15000 (1034)
2FH6	MP6	SS-FMA-2FH6-MP6	1.56 (39.7)	0.75 (19.1)	0.20 (5.2)	15000 (1034)
2FH6	MP8	SS-FMA-2FH6-MP8	1.56 (39.7)	0.94 (23.8)	0.20 (5.2)	15000 (1034)
2FH9	MP2	SS-FMA-2FH9-MP2	1.75 (44.5)	1.00 (25.4)	0.09 (2.4)	15000 (1034)
2FH9	MP4	SS-FMA-2FH9-MP4	1.87 (47.6)	1.00 (25.4)	0.19 (4.8)	15000 (1034)
2FH9	MP6	SS-FMA-2FH9-MP6	1.94 (49.2)	1.00 (25.4)	0.25 (6.4)	15000 (1034)
2FH9	MP8	SS-FMA-2FH9-MP8	1.87 (47.6)	1.00 (25.4)	0.31 (7.9)	15000 (1034)
2FH12	MP2	SS-FMA-2FH12-MP2	2.06 (52.4)	1.37 (34.9)	0.09 (2.4)	15000 (1034)
2FH12	MP4	SS-FMA-2FH12-MP4	2.19 (55.6)	1.37 (34.9)	0.19 (4.8)	15000 (1034)
2FH12	MP6	SS-FMA-2FH12-MP6	2.19 (55.6)	1.37 (34.9)	0.25 (6.4)	15000 (1034)
2FH12	MP8	SS-FMA-2FH12-MP8	2.25 (57.2)	1.37 (34.9)	0.37 (7.9)	15000 (1034)
2FH16	MP2	SS-FMA-2FH16-MP2	2.63 (66.7)	1.75 (44.5)	0.09 (2.4)	15000 (1034)
2FH16	MP4	SS-FMA-2FH16-MP4	2.75 (69.9)	1.75 (44.5)	0.19 (4.8)	15000 (1034)
2FH16	MP6	SS-FMA-2FH16-MP6	2.81 (71.4)	1.75 (44.5)	0.25 (6.4)	15000 (1034)
2FH16	MP8	SS-FMA-2FH16-MP8	2.81 (71.4)	1.75 (44.5)	0.37 (9.5)	15000 (1034)

20 Series Female to 20 Series Male

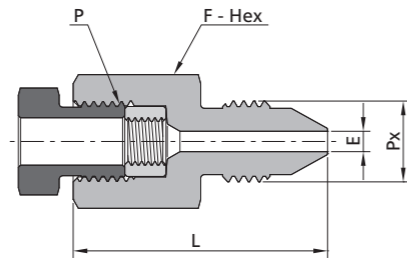

20 Series Female			20 Series Male			
P-Connection Type	Px-Connection Type	Ordering Number	Dimension, in. (mm)			Working Pressure psig (bar)
			L	F	E	
2FH4	2MP4	SS-FMA-2FH4-2MP4	1.37 (34.9)	0.63 (15.9)	0.11 (2.8)	20000 (1379)
2FH4	2MP6	SS-FMA-2FH4-2MP6	1.50 (38.1)	0.63 (15.9)	0.11 (2.8)	20000 (1379)
2FH4	2MP9	SS-FMA-2FH4-2MP9	1.63 (41.3)	0.94 (23.8)	0.11 (2.8)	20000 (1379)
2FH4	2MP12	SS-FMA-2FH4-2MP12	1.75 (44.5)	1.19 (30.2)	0.11 (2.8)	20000 (1379)
2FH4	2MP16	SS-FMA-2FH4-2MP16	2.37 (60.3)	1.50 (38.1)	0.11 (2.8)	20000 (1379)
2FH6	2MP4	SS-FMA-2FH6-2MP4	1.69 (42.9)	0.75 (19.1)	0.11 (2.8)	20000 (1379)
2FH6	2MP6	SS-FMA-2FH6-2MP6	1.69 (42.9)	0.75 (19.1)	0.20 (5.2)	20000 (1379)
2FH6	2MP9	SS-FMA-2FH6-2MP9	1.87 (47.6)	0.94 (23.8)	0.20 (5.2)	20000 (1379)
2FH6	2MP12	SS-FMA-2FH6-2MP12	1.94 (49.2)	1.19 (30.2)	0.20 (5.2)	20000 (1379)
2FH6	2MP16	SS-FMA-2FH6-2MP16	2.37 (60.3)	1.50 (38.1)	0.20 (5.2)	20000 (1379)
2FH9	2MP4	SS-FMA-2FH9-2MP4	1.94 (49.2)	1.00 (25.4)	0.11 (2.8)	20000 (1379)
2FH9	2MP6	SS-FMA-2FH9-2MP6	2.06 (52.4)	1.00 (25.4)	0.20 (5.2)	20000 (1379)
2FH9	2MP9	SS-FMA-2FH9-2MP9	2.13 (54.0)	1.00 (25.4)	0.31 (7.9)	20000 (1379)
2FH9	2MP12	SS-FMA-2FH9-2MP12	2.25 (57.2)	1.19 (30.2)	0.31 (7.9)	20000 (1379)
2FH9	2MP16	SS-FMA-2FH9-2MP16	2.50 (63.5)	1.50 (38.1)	0.31 (7.9)	20000 (1379)
2FH12	2MP4	SS-FMA-2FH12-2MP4	2.19 (55.6)	1.37 (34.9)	0.11 (2.8)	20000 (1379)
2FH12	2MP6	SS-FMA-2FH12-2MP6	2.31 (58.7)	1.37 (34.9)	0.20 (5.2)	20000 (1379)
2FH12	2MP9	SS-FMA-2FH12-2MP9	2.44 (61.9)	1.37 (34.9)	0.31 (7.9)	20000 (1379)
2FH12	2MP12	SS-FMA-2FH12-2MP12	2.56 (65.1)	1.37 (34.9)	0.44 (11.1)	20000 (1379)
2FH12	2MP16	SS-FMA-2FH12-2MP16	2.94 (74.6)	1.50 (38.1)	0.44 (11.1)	20000 (1379)
2FH16	2MP9	SS-FMA-2FH16-2MP9	3.06 (77.8)	1.75 (44.5)	0.31 (7.9)	20000 (1379)
2FH16	2MP12	SS-FMA-2FH16-2MP12	3.19 (81.0)	1.75 (44.5)	0.44 (11.1)	20000 (1379)
2FH16	2MP16	SS-FMA-2FH16-2MP16	3.50 (88.9)	1.75 (44.5)	0.56 (14.3)	20000 (1379)

20 Series Female to 60 Series Male

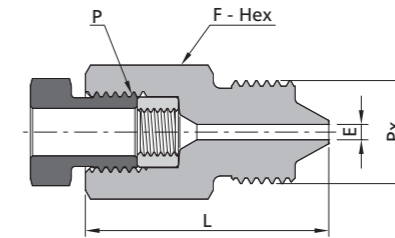

20 Series Female			60 Series Male			
P-Connection Type	Px-Connection Type	Ordering Number	Dimension, in. (mm)			Working Pressure psig (bar)
			L	F	E	
2FH4	6MP4	SS-FMA-2FH4-6MP4	1.31 (33.3)	0.63 (15.9)	0.08 (2.1)	20000 (1379)
2FH4	6MP6	SS-FMA-2FH4-6MP6	1.50 (38.1)	0.81 (20.6)	0.11 (2.8)	20000 (1379)
2FH4	6MP9	SS-FMA-2FH4-6MP9	1.63 (41.3)	1.19 (30.2)	0.11 (2.8)	20000 (1379)
2FH6	6MP4	SS-FMA-2FH6-6MP4	1.50 (38.1)	0.75 (19.1)	0.08 (2.1)	20000 (1379)
2FH6	6MP6	SS-FMA-2FH6-6MP6	1.69 (42.9)	0.81 (20.6)	0.13 (3.2)	20000 (1379)
2FH6	6MP9	SS-FMA-2FH6-6MP9	1.75 (44.5)	1.19 (30.2)	0.19 (4.8)	20000 (1379)
2FH9	6MP4	SS-FMA-2FH9-6MP4	1.81 (46.0)	1.00 (25.4)	0.08 (2.1)	20000 (1379)
2FH9	6MP6	SS-FMA-2FH9-6MP6	2.13 (54.0)	1.00 (25.4)	0.13 (3.2)	20000 (1379)
2FH9	6MP9	SS-FMA-2FH9-6MP9	2.13 (54.0)	1.19 (30.2)	0.19 (4.8)	20000 (1379)
2FH12	6MP4	SS-FMA-2FH12-6MP4	2.25 (57.2)	1.37 (34.9)	0.08 (2.1)	20000 (1379)
2FH12	6MP6	SS-FMA-2FH12-6MP6	2.50 (63.5)	1.37 (34.9)	0.13 (3.2)	20000 (1379)
2FH12	6MP9	SS-FMA-2FH12-6MP9	2.50 (63.5)	1.37 (34.9)	0.19 (4.8)	20000 (1379)
2FH16	6MP4	SS-FMA-2FH16-6MP4	2.94 (74.6)	1.75 (44.5)	0.08 (2.1)	20000 (1379)
2FH16	6MP6	SS-FMA-2FH16-6MP6	3.13 (79.4)	1.75 (44.5)	0.13 (3.2)	20000 (1379)
2FH16	6MP9	SS-FMA-2FH16-6MP9	3.19 (81.0)	1.75 (44.5)	0.19 (4.8)	20000 (1379)

20 Series Female to Male NPT Thread

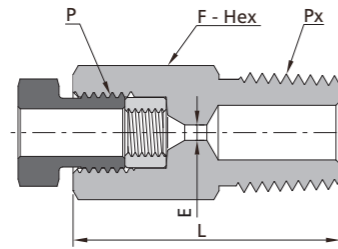

20 Series Female			Male NPT Thread			
P-Connection Type	Px-Connection Type	Ordering Number	Dimension, in. (mm)			Working Pressure psig (bar)
			L	F	E	
2FH4	1/8 NPT	SS-FMA-2FH4-NS2	1.19 (30.2)	0.63 (15.9)	0.11 (2.8)	15000 (1034)
2FH4	1/4 NPT	SS-FMA-2FH4-NS4	1.37 (34.9)	0.63 (15.9)	0.11 (2.8)	15000 (1034)
2FH4	3/8 NPT	SS-FMA-2FH4-NS6	1.37 (34.9)	0.69 (17.5)	0.11 (2.8)	15000 (1034)
2FH4	1/2 NPT	SS-FMA-2FH4-NS8	1.37 (34.9)	0.87 (22.2)	0.11 (2.8)	15000 (1034)
2FH4	3/4 NPT	SS-FMA-2FH4-NS12	1.75 (44.5)	1.06 (27.0)	0.11 (2.8)	10000 (690)
2FH6	1/8 NPT	SS-FMA-2FH6-NS2	1.37 (34.9)	0.75 (19.1)	0.19 (4.8)	15000 (1034)
2FH6	1/4 NPT	SS-FMA-2FH6-NS4	1.50 (38.1)	0.75 (19.1)	0.20 (5.2)	15000 (1034)
2FH6	3/8 NPT	SS-FMA-2FH6-NS6	1.50 (38.1)	0.75 (19.1)	0.20 (5.2)	15000 (1034)
2FH6	1/2 NPT	SS-FMA-2FH6-NS8	1.63 (41.3)	0.87 (22.2)	0.20 (5.2)	15000 (1034)
2FH6	3/4 NPT	SS-FMA-2FH6-NS12	1.75 (44.5)	1.06 (27.0)	0.20 (5.2)	10000 (690)
2FH6	1 NPT	SS-FMA-2FH6-NS16	2.00 (50.8)	1.37 (34.9)	0.20 (5.2)	10000 (690)
2FH9	1/8 NPT	SS-FMA-2FH9-NS2	1.75 (44.5)	1.00 (25.4)	0.19 (4.8)	15000 (1034)
2FH9	1/4 NPT	SS-FMA-2FH9-NS4	1.75 (44.5)	1.00 (25.4)	0.25 (6.4)	15000 (1034)
2FH9	3/8 NPT	SS-FMA-2FH9-NS6	1.75 (44.5)	1.00 (25.4)	0.31 (7.9)	15000 (1034)
2FH9	1/2 NPT	SS-FMA-2FH9-NS8	1.94 (49.2)	1.00 (25.4)	0.31 (7.9)	15000 (1034)
2FH9	3/4 NPT	SS-FMA-2FH9-NS12	2.00 (50.8)	1.06 (27.0)	0.31 (7.9)	10000 (690)
2FH9	1 NPT	SS-FMA-2FH9-NS16	2.25 (57.2)	1.37 (34.9)	0.31 (7.9)	10000 (690)
2FH12	1/4 NPT	SS-FMA-2FH12-NS4	2.00 (50.8)	1.37 (34.9)	0.25 (6.4)	15000 (1034)
2FH12	3/8 NPT	SS-FMA-2FH12-NS6	2.00 (50.8)	1.37 (34.9)	0.31 (7.9)	15000 (1034)
2FH12	1/2 NPT	SS-FMA-2FH12-NS8	2.19 (55.6)	1.37 (34.9)	0.38 (9.6)	15000 (1034)
2FH12	3/4 NPT	SS-FMA-2FH12-NS12	2.25 (57.2)	1.37 (34.9)	0.44 (11.1)	10000 (690)
2FH12	1 NPT	SS-FMA-2FH12-NS16	2.63 (66.7)	1.37 (34.9)	0.44 (11.1)	10000 (690)
2FH16	1/4 NPT	SS-FMA-2FH16-NS4	2.87 (73.0)	1.75 (44.5)	0.25 (6.4)	15000 (1034)
2FH16	3/8 NPT	SS-FMA-2FH16-NS6	2.87 (73.0)	1.75 (44.5)	0.31 (7.9)	15000 (1034)
2FH16	1/2 NPT	SS-FMA-2FH16-NS8	2.87 (73.0)	1.75 (44.5)	0.38 (9.6)	15000 (1034)
2FH16	3/4 NPT	SS-FMA-2FH16-NS12	2.87 (73.0)	1.75 (44.5)	0.56 (14.3)	10000 (690)
2FH16	1 NPT	SS-FMA-2FH16-NS16	3.06 (77.8)	1.75 (44.5)	0.56 (14.3)	10000 (690)

20 Series Female to Type "M" Male

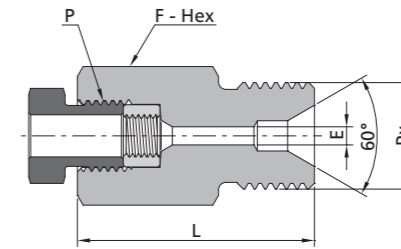

20 Series Female			Type "M" Male			
P-Connection Type	Px-Connection Type	Ordering Number	Dimension, in. (mm)			Working Pressure psig (bar)
			L	F	E	
2FH4	HM9	SS-FMA-2FH4-HM9	1.19 (30.2)	0.63 (15.9)	0.09 (2.4)	20000 (1379)
2FH4	HM12	SS-FMA-2FH4-HM12	1.31 (33.3)	0.75 (19.1)	0.11 (2.8)	20000 (1379)
2FH4	HM14	SS-FMA-2FH4-HM14	1.50 (38.1)	1.00 (25.4)	0.11 (2.8)	20000 (1379)
2FH6	HM9	SS-FMA-2FH6-HM9	1.37 (34.9)	0.75 (19.1)	0.09 (2.4)	20000 (1379)
2FH6	HM12	SS-FMA-2FH6-HM12	1.50 (38.1)	0.75 (19.1)	0.09 (2.4)	20000 (1379)
2FH6	HM14	SS-FMA-2FH6-HM14	1.63 (41.3)	1.00 (25.4)	0.15 (3.8)	20000 (1379)
2FH6	HM16	SS-FMA-2FH6-HM16	1.63 (41.3)	1.00 (25.4)	0.20 (5.2)	20000 (1379)
2FH9	HM9	SS-FMA-2FH9-HM9	1.69 (42.9)	1.00 (25.4)	0.09 (2.4)	20000 (1379)
2FH9	HM12	SS-FMA-2FH9-HM12	1.81 (46.0)	1.00 (25.4)	0.29 (7.4)	20000 (1379)
2FH9	HM14	SS-FMA-2FH9-HM14	1.94 (49.2)	1.00 (25.4)	0.15 (3.8)	20000 (1379)
2FH9	HM16	SS-FMA-2FH9-HM16	1.81 (46.0)	1.00 (25.4)	0.31 (7.9)	20000 (1379)
2FH9	HM21	SS-FMA-2FH9-HM21	1.81 (46.0)	1.37 (34.9)	0.31 (7.9)	20000 (1379)
2FH12	HM14	SS-FMA-2FH12-HM14	2.19 (55.6)	1.37 (34.9)	0.15 (3.8)	20000 (1379)
2FH12	HM16	SS-FMA-2FH12-HM16	2.13 (54.0)	1.37 (34.9)	0.39 (10.0)	20000 (1379)
2FH12	HM21	SS-FMA-2FH12-HM21	2.00 (50.8)	1.37 (34.9)	0.44 (11.1)	20000 (1379)
2FH16	HM21	SS-FMA-2FH16-HM21	2.56 (65.1)	1.75 (44.5)	0.56 (14.3)	20000 (1379)

**60 Series Female to 15 Series Male**

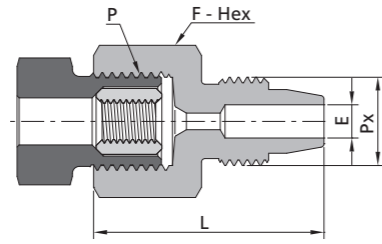

60 Series Female			15 Series Male			
P-Connection Type	Px-Connection Type	Ordering Number	Dimension, in. (mm)			Working Pressure psig (bar)
			L	F	E	
6FH4	MP2	SS-FMA-6FH4-MP2	1.19 (30.2)	0.75 (19.1)	0.09 (2.4)	15000 (1034)
6FH4	MP4	SS-FMA-6FH4-MP4	1.31 (33.3)	0.75 (19.1)	0.09 (2.4)	15000 (1034)
6FH4	MP6	SS-FMA-6FH4-MP6	1.37 (34.9)	0.75 (19.1)	0.09 (2.4)	15000 (1034)
6FH4	MP8	SS-FMA-6FH4-MP8	1.37 (34.9)	0.94 (23.8)	0.09 (2.4)	15000 (1034)
6FH6	MP2	SS-FMA-6FH6-MP2	1.44 (36.5)	1.00 (25.4)	0.09 (2.4)	15000 (1034)
6FH6	MP4	SS-FMA-6FH6-MP4	1.56 (39.7)	1.00 (25.4)	0.13 (3.2)	15000 (1034)
6FH6	MP6	SS-FMA-6FH6-MP6	1.63 (41.3)	1.00 (25.4)	0.13 (3.2)	15000 (1034)
6FH6	MP8	SS-FMA-6FH6-MP8	1.69 (42.9)	1.00 (25.4)	0.13 (3.2)	15000 (1034)
6FH9	MP2	SS-FMA-6FH8-MP2	1.75 (44.5)	1.37 (34.9)	0.09 (2.4)	15000 (1034)
6FH9	MP4	SS-FMA-6FH8-MP4	1.75 (44.5)	1.37 (34.9)	0.19 (4.8)	15000 (1034)
6FH9	MP6	SS-FMA-6FH8-MP6	1.81 (46.0)	1.37 (34.9)	0.19 (4.8)	15000 (1034)
6FH9	MP8	SS-FMA-6FH8-MP8	1.87 (47.6)	1.37 (34.9)	0.19 (4.8)	15000 (1034)

**60 Series Female to 20 Series Male**

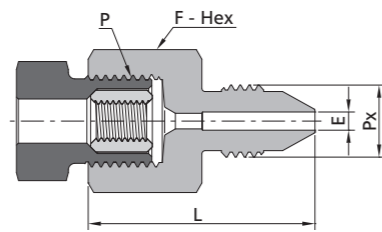

60 Series Female			20 Series Male			
P-Connection Type	Px-Connection Type	Ordering Number	Dimension, in. (mm)			Working Pressure psig (bar)
			L	F	E	
6FH4	2MP4	SS-FMA-6FH4-2MP4	1.37 (34.9)	0.75 (19.1)	0.09 (2.4)	20000 (1379)
6FH4	2MP6	SS-FMA-6FH4-2MP6	1.50 (38.1)	0.75 (19.1)	0.09 (2.4)	20000 (1379)
6FH4	2MP9	SS-FMA-6FH4-2MP9	1.69 (42.9)	0.94 (23.8)	0.09 (2.4)	20000 (1379)
6FH4	2MP12	SS-FMA-6FH4-2MP12	1.75 (44.5)	1.19 (30.2)	0.09 (2.4)	20000 (1379)
6FH4	2MP16	SS-FMA-6FH4-2MP16	2.37 (60.3)	1.50 (38.1)	0.09 (2.4)	20000 (1379)
6FH6	2MP4	SS-FMA-6FH6-2MP4	1.67 (42.3)	1.00 (25.4)	0.11 (2.8)	20000 (1379)
6FH6	2MP6	SS-FMA-6FH6-2MP6	1.81 (46.0)	1.00 (25.4)	0.13 (3.2)	20000 (1379)
6FH6	2MP9	SS-FMA-6FH6-2MP9	1.94 (49.2)	1.00 (25.4)	0.13 (3.2)	20000 (1379)
6FH6	2MP12	SS-FMA-6FH6-2MP12	2.13 (54.0)	1.19 (30.2)	0.13 (3.2)	20000 (1379)
6FH6	2MP16	SS-FMA-6FH6-2MP16	2.50 (63.5)	1.50 (38.1)	0.13 (3.2)	20000 (1379)
6FH9	2MP4	SS-FMA-6FH9-2MP4	1.87 (47.6)	1.37 (34.9)	0.11 (2.8)	20000 (1379)
6FH9	2MP6	SS-FMA-6FH9-2MP6	2.00 (50.8)	1.37 (34.9)	0.19 (4.8)	20000 (1379)
6FH9	2MP9	SS-FMA-6FH9-2MP9	2.19 (55.6)	1.37 (34.9)	0.19 (4.8)	20000 (1379)
6FH9	2MP12	SS-FMA-6FH9-2MP12	2.37 (60.3)	1.37 (34.9)	0.19 (4.8)	20000 (1379)
6FH9	2MP16	SS-FMA-6FH9-2MP16	2.81 (71.4)	1.50 (38.1)	0.19 (4.8)	20000 (1379)

**60 Series Female to 60 Series Male**

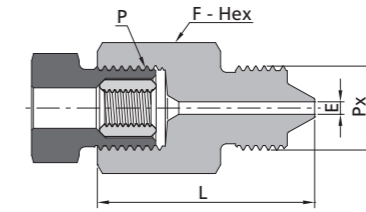

60 Series Female			60 Series Male			
P-Connection Type	Px-Connection Type	Ordering Number	Dimension, in. (mm)			Working Pressure psig (bar)
			L	F	E	
6FH4	6MP4	SS-FMA-6FH4-6MP4	1.44 (36.5)	0.75 (19.1)	0.08 (2.1)	60000 (4137)
6FH4	6MP6	SS-FMA-6FH4-6MP6	1.69 (42.9)	0.81 (20.6)	0.09 (2.4)	60000 (4137)
6FH4	6MP9	SS-FMA-6FH4-6MP9	1.75 (44.5)	1.19 (30.2)	0.09 (2.4)	60000 (4137)
6FH6	6MP4	SS-FMA-6FH6-6MP4	1.75 (44.5)	1.00 (25.4)	0.08 (2.1)	60000 (4137)
6FH6	6MP6	SS-FMA-6FH6-6MP6	2.00 (50.8)	1.00 (25.4)	0.13 (3.2)	60000 (4137)
6FH6	6MP9	SS-FMA-6FH6-6MP9	2.13 (54.0)	1.19 (30.2)	0.13 (3.2)	60000 (4137)
6FH9	6MP4	SS-FMA-6FH9-6MP4	2.06 (52.4)	1.37 (34.9)	0.08 (2.1)	60000 (4137)
6FH9	6MP6	SS-FMA-6FH9-6MP6	2.37 (60.3)	1.37 (34.9)	0.13 (3.2)	60000 (4137)
6FH9	6MP9	SS-FMA-6FH9-6MP9	2.50 (63.5)	1.37 (34.9)	0.19 (4.8)	60000 (4137)

**60 Series Female to Male NPT Thread**

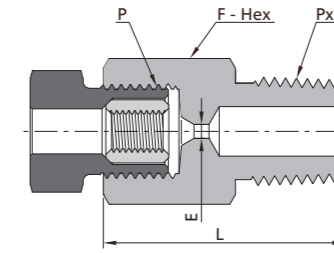

60 Series Female			Male NPT Threads			Working Pressure psig (bar)
P-Connection Type	Px-Connection Type	Ordering Number	Dimension, in. (mm)			
			L	F	E	
6FH4	1/8 NPT	SS-FMA-6FH4-NS2	1.25 (31.8)	0.75 (19.1)	0.09 (2.4)	15000 (1034)
6FH4	1/4 NPT	SS-FMA-6FH4-NS4	1.37 (34.9)	0.75 (19.1)	0.09 (2.4)	15000 (1034)
6FH4	3/8 NPT	SS-FMA-6FH4-NS6	1.37 (34.9)	0.75 (19.1)	0.09 (2.4)	15000 (1034)
6FH4	1/2 NPT	SS-FMA-6FH4-NS8	1.50 (38.1)	0.87 (22.2)	0.09 (2.4)	15000 (1034)
6FH4	3/4 NPT	SS-FMA-6FH4-NS12	1.75 (44.5)	1.06 (27.0)	0.09 (2.4)	10000 (690)
6FH6	1/8 NPT	SS-FMA-6FH6-NS2	1.50 (38.1)	1.00 (25.4)	0.13 (3.2)	15000 (1034)
6FH6	1/4 NPT	SS-FMA-6FH6-NS4	1.63 (41.3)	1.00 (25.4)	0.13 (3.2)	15000 (1034)
6FH6	3/8 NPT	SS-FMA-6FH6-NS6	1.63 (41.3)	1.00 (25.4)	0.13 (3.2)	15000 (1034)
6FH6	1/2 NPT	SS-FMA-6FH6-NS8	1.75 (44.5)	1.00 (25.4)	0.13 (3.2)	15000 (1034)
6FH6	3/4 NPT	SS-FMA-6FH6-NS12	2.00 (50.8)	1.06 (27.0)	0.13 (3.2)	10000 (690)
6FH6	1 NPT	SS-FMA-6FH6-NS16	2.00 (50.8)	1.37 (34.9)	0.13 (3.2)	10000 (690)
6FH9	1/8 NPT	SS-FMA-6FH9-NS2	1.63 (41.3)	1.37 (34.9)	0.19 (4.8)	15000 (1034)
6FH9	1/4 NPT	SS-FMA-6FH9-NS4	1.75 (44.5)	1.37 (34.9)	0.19 (4.8)	15000 (1034)
6FH9	3/8 NPT	SS-FMA-6FH9-NS6	1.75 (44.5)	1.37 (34.9)	0.19 (4.8)	15000 (1034)
6FH9	1/2 NPT	SS-FMA-6FH9-NS8	1.87 (47.6)	1.37 (34.9)	0.19 (4.8)	15000 (1034)
6FH9	3/4 NPT	SS-FMA-6FH9-NS12	2.13 (54.0)	1.37 (34.9)	0.19 (4.8)	10000 (690)
6FH9	1 NPT	SS-FMA-6FH9-NS16	2.25 (57.2)	1.37 (34.9)	0.19 (4.8)	10000 (690)



60 Series Female to Type "M" Male

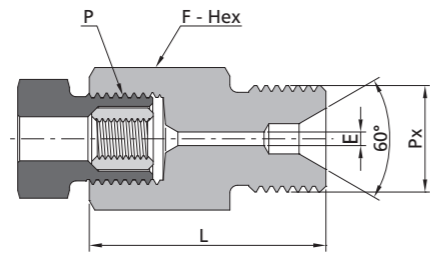

60 Series Female			Type "M" Male			
P-Connection Type	Px-Connection Type	Ordering Number	Dimension, in. (mm)			Working Pressure psig (bar)
			L	F	E	
6FH4	HM9	SS-FMA-6FH4-HM9	1.25 (31.8)	0.75 (19.1)	0.09 (2.4)	60000 (4137)
6FH4	HM12	SS-FMA-6FH4-HM12	1.38 (35.0)	0.75 (19.1)	0.09 (2.4)	30000 (2068)
6FH4	HM14	SS-FMA-6FH4-HM14	1.56 (39.7)	1.00 (25.4)	0.09 (2.4)	50000 (3447)
6FH4	HM16	SS-FMA-6FH4-HM16	1.37 (34.9)	1.00 (25.4)	0.09 (2.4)	30000 (2068)
6FH6	HM9	SS-FMA-6FH6-HM9	1.50 (38.1)	1.00 (25.4)	0.09 (2.4)	60000 (4137)
6FH6	HM12	SS-FMA-6FH6-HM12	1.63 (41.3)	1.00 (25.4)	0.13 (3.2)	30000 (2068)
6FH6	HM14	SS-FMA-6FH6-HM14	1.81 (46.0)	1.00 (25.4)	0.13 (3.2)	50000 (3447)
6FH6	HM16	SS-FMA-6FH6-HM16	1.64 (41.6)	1.00 (25.4)	0.13 (3.2)	30000 (2068)
6FH6	HM21	SS-FMA-6FH6-HM21	1.56 (39.7)	1.37 (34.9)	0.13 (3.2)	20000 (1379)
6FH9	HM14	SS-FMA-6FH9-HM14	2.00 (50.8)	1.37 (34.9)	0.15 (3.8)	50000 (3447)
6FH9	HM16	SS-FMA-6FH9-HM16	1.81 (46.0)	1.37 (34.9)	0.19 (4.8)	30000 (2068)
6FH9	HM21	SS-FMA-6FH9-HM21	1.81 (46.0)	1.37 (34.9)	0.19 (4.8)	20000 (1379)

Female NPT Threads to 15 Series Male

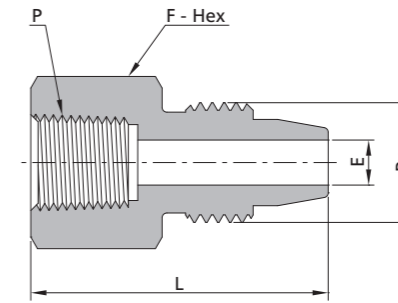

Female NPT Threads			15 Series Male			
P-Connection Type	Px-Connection Type	Ordering Number	Dimension, in. (mm)			Working Pressure psig (bar)
			L	F	E	
1/8 NPT	MP2	SS-FMA-NS2-MP2	1.13 (28.6)	0.63 (15.9)	0.09 (2.4)	15000 (1034)
1/8 NPT	MP4	SS-FMA-NS2-MP4	1.25 (31.7)	0.63 (15.9)	0.19 (4.8)	15000 (1034)
1/8 NPT	MP6	SS-FMA-NS2-MP6	1.31 (33.3)	0.75 (19.1)	0.25 (6.4)	15000 (1034)
1/8 NPT	MP8	SS-FMA-NS2-MP8	1.31 (33.3)	0.94 (23.8)	0.37 (9.5)	15000 (1034)
1/4 NPT	MP2	SS-FMA-NS4-MP2	1.31 (33.3)	0.94 (23.8)	0.09 (2.4)	15000 (1034)
1/4 NPT	MP4	SS-FMA-NS4-MP4	1.50 (38.1)	0.94 (23.8)	0.19 (4.8)	15000 (1034)
1/4 NPT	MP6	SS-FMA-NS4-MP6	1.56 (39.7)	0.94 (23.8)	0.25 (6.4)	15000 (1034)
1/4 NPT	MP8	SS-FMA-NS4-MP8	1.56 (39.7)	0.94 (23.8)	0.37 (9.5)	15000 (1034)
3/8 NPT	MP2	SS-FMA-NS6-MP2	1.44 (36.5)	1.13 (28.6)	0.09 (2.4)	15000 (1034)
3/8 NPT	MP4	SS-FMA-NS6-MP4	1.56 (39.7)	1.13 (28.6)	0.19 (4.8)	15000 (1034)
3/8 NPT	MP6	SS-FMA-NS6-MP6	1.63 (41.3)	1.13 (28.6)	0.25 (6.4)	15000 (1034)
3/8 NPT	MP8	SS-FMA-NS6-MP8	1.69 (42.9)	1.13 (28.6)	0.37 (9.5)	15000 (1034)
1/2 NPT	MP2	SS-FMA-NS8-MP2	1.63 (41.3)	1.37 (34.9)	0.09 (2.4)	15000 (1034)
1/2 NPT	MP4	SS-FMA-NS8-MP4	1.75 (44.5)	1.37 (34.9)	0.19 (4.8)	15000 (1034)
1/2 NPT	MP6	SS-FMA-NS8-MP6	1.87 (47.6)	1.37 (34.9)	0.25 (6.4)	15000 (1034)
1/2 NPT	MP8	SS-FMA-NS8-MP8	1.87 (47.6)	1.37 (34.9)	0.37 (9.5)	15000 (1034)
3/4 NPT	MP2	SS-FMA-NS12-MP2	1.69 (42.9)	1.50 (38.1)	0.09 (2.4)	10000 (690)
3/4 NPT	MP4	SS-FMA-NS12-MP4	1.87 (47.6)	1.50 (38.1)	0.19 (4.8)	10000 (690)
3/4 NPT	MP6	SS-FMA-NS12-MP6	1.94 (49.2)	1.50 (38.1)	0.25 (6.4)	10000 (690)
3/4 NPT	MP8	SS-FMA-NS12-MP8	1.94 (49.2)	1.50 (38.1)	0.37 (9.5)	10000 (690)
1 NPT	MP2	SS-FMA-NS16-MP2	2.00 (50.8)	1.75 (44.5)	0.09 (2.4)	10000 (690)
1 NPT	MP4	SS-FMA-NS16-MP4	2.13 (54.0)	1.75 (44.5)	0.19 (4.8)	10000 (690)
1 NPT	MP6	SS-FMA-NS16-MP6	2.19 (55.6)	1.75 (44.5)	0.25 (6.4)	10000 (690)
1 NPT	MP8	SS-FMA-NS16-MP8	2.19 (55.6)	1.75 (44.5)	0.37 (9.5)	10000 (690)

Female NPT Threads to 20 Series Male

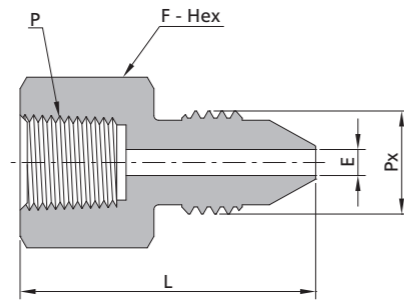

Female NPT Threads			20 Series Male			
P-Connection Type	Px-Connection Type	Ordering Number	Dimension, in. (mm)			Working Pressure psig (bar)
			L	F	E	
1/8 NPT	2MP4	SS-FMA-NS2-2MP4	1.25 (31.8)	0.63 (15.9)	0.11 (2.8)	15000 (1034)
1/8 NPT	2MP6	SS-FMA-NS2-2MP6	1.37 (34.9)	0.63 (15.9)	0.20 (5.2)	15000 (1034)
1/8 NPT	2MP9	SS-FMA-NS2-2MP9	1.50 (38.1)	0.94 (23.8)	0.31 (7.9)	15000 (1034)
1/8 NPT	2MP12	SS-FMA-NS2-2MP12	1.75 (44.5)	1.19 (30.2)	0.31 (7.9)	15000 (1034)
1/8 NPT	2MP16	SS-FMA-NS2-2MP16	2.37 (60.3)	1.50 (38.1)	0.31 (7.9)	15000 (1034)
1/4 NPT	2MP4	SS-FMA-NS4-2MP4	1.44 (36.5)	0.94 (23.8)	0.11 (2.8)	15000 (1034)
1/4 NPT	2MP6	SS-FMA-NS4-2MP6	1.63 (41.3)	0.94 (23.8)	0.20 (5.2)	15000 (1034)
1/4 NPT	2MP9	SS-FMA-NS4-2MP9	1.75 (44.5)	0.94 (23.8)	0.31 (7.9)	15000 (1034)
1/4 NPT	2MP12	SS-FMA-NS4-2MP12	1.87 (47.6)	1.19 (30.2)	0.41 (10.4)	15000 (1034)
1/4 NPT	2MP16	SS-FMA-NS4-2MP16	2.37 (60.3)	1.50 (38.1)	0.41 (10.4)	15000 (1034)
3/8 NPT	2MP4	SS-FMA-NS6-2MP4	1.50 (38.1)	1.13 (28.6)	0.11 (2.8)	15000 (1034)
3/8 NPT	2MP6	SS-FMA-NS6-2MP6	1.69 (42.9)	1.13 (28.6)	0.20 (5.2)	15000 (1034)
3/8 NPT	2MP9	SS-FMA-NS6-2MP9	1.81 (46.0)	1.13 (28.6)	0.31 (7.9)	15000 (1034)
3/8 NPT	2MP12	SS-FMA-NS6-2MP12	2.00 (50.8)	1.19 (30.2)	0.44 (11.1)	15000 (1034)
3/8 NPT	2MP16	SS-FMA-NS6-2MP16	2.37 (60.3)	1.50 (38.1)	0.56 (14.3)	15000 (1034)
1/2 NPT	2MP4	SS-FMA-NS8-2MP4	1.75 (44.5)	1.37 (34.9)	0.11 (2.8)	15000 (1034)
1/2 NPT	2MP6	SS-FMA-NS8-2MP6	1.87 (47.6)	1.37 (34.9)	0.20 (5.2)	15000 (1034)
1/2 NPT	2MP9	SS-FMA-NS8-2MP9	2.06 (52.4)	1.37 (34.9)	0.31 (7.9)	15000 (1034)
1/2 NPT	2MP12	SS-FMA-NS8-2MP12	2.19 (55.6)	1.37 (34.9)	0.44 (11.1)	15000 (1034)
1/2 NPT	2MP16	SS-FMA-NS8-2MP16	2.56 (65.1)	1.50 (38.1)	0.56 (14.3)	15000 (1034)
3/4 NPT	2MP4	SS-FMA-NS12-2MP4	1.81 (46.0)	1.50 (38.1)	0.11 (2.8)	10000 (690)
3/4 NPT	2MP6	SS-FMA-NS12-2MP6	1.94 (49.2)	1.50 (38.1)	0.20 (5.2)	10000 (690)
3/4 NPT	2MP9	SS-FMA-NS12-2MP9	2.13 (54.0)	1.50 (38.1)	0.31 (7.9)	10000 (690)
3/4 NPT	2MP12	SS-FMA-NS12-2MP12	2.31 (58.7)	1.50 (38.1)	0.44 (11.1)	10000 (690)
3/4 NPT	2MP16	SS-FMA-NS12-2MP16	2.75 (69.9)	1.50 (38.1)	0.56 (14.3)	10000 (690)
1 NPT	2MP4	SS-FMA-NS16-2MP4	2.06 (52.4)	1.75 (44.5)	0.11 (2.8)	10000 (690)
1 NPT	2MP6	SS-FMA-NS16-2MP6	2.19 (55.6)	1.75 (44.5)	0.20 (5.2)	10000 (690)
1 NPT	2MP9	SS-FMA-NS16-2MP9	2.44 (61.9)	1.75 (44.5)	0.31 (7.9)	10000 (690)
1 NPT	2MP12	SS-FMA-NS16-2MP12	2.56 (63.5)	1.75 (44.5)	0.44 (11.1)	10000 (690)
1 NPT	2MP16	SS-FMA-NS16-2MP16	3.06 (77.8)	1.75 (44.5)	0.56 (14.3)	10000 (690)

Female NPT Threads to 20 Series Coned and Threaded Nipples

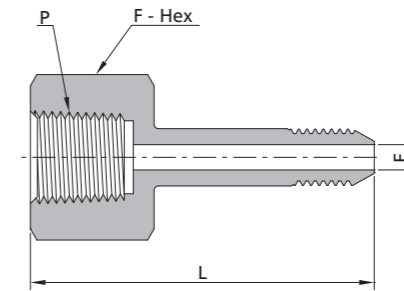

Female NPT Threads			20 Series Coned and Threaded Nipples			
P-Connection Type	Px-Connection Type	Ordering Number	Dimension, in. (mm)			Working Pressure psig (bar)
			L	F	E	
1/8 NPT	2CT4	SS-FMA-NS2-2CT4	1.50 (38.1)	0.63 (15.9)	0.11 (2.8)	15000 (1034)
1/8 NPT	2CT6	SS-FMA-NS2-2CT6	1.75 (44.5)	0.63 (15.9)	0.20 (5.2)	15000 (1034)
1/8 NPT	2CT9	SS-FMA-NS2-2CT9	1.94 (49.2)	0.63 (15.9)	0.31 (7.9)	15000 (1034)
1/8 NPT	2CT12	SS-FMA-NS2-2CT12	2.13 (54.0)	0.87 (22.2)	0.31 (7.9)	15000 (1034)
1/8 NPT	2CT16	SS-FMA-NS2-2CT16	2.81 (71.4)	1.13 (28.6)	0.31 (7.9)	15000 (1034)
1/4 NPT	2CT4	SS-FMA-NS4-2CT4	1.75 (44.5)	0.94 (23.8)	0.11 (2.8)	15000 (1034)
1/4 NPT	2CT6	SS-FMA-NS4-2CT6	2.00 (50.8)	0.94 (23.8)	0.20 (5.2)	15000 (1034)
1/4 NPT	2CT9	SS-FMA-NS4-2CT9	2.19 (55.6)	0.94 (23.8)	0.31 (7.9)	15000 (1034)
1/4 NPT	2CT12	SS-FMA-NS4-2CT12	2.44 (61.9)	0.94 (23.8)	0.41 (10.4)	15000 (1034)
1/4 NPT	2CT16	SS-FMA-NS4-2CT16	2.94 (74.6)	1.13 (28.6)	0.41 (10.4)	15000 (1034)
3/8 NPT	2CT6	SS-FMA-NS6-2CT6	2.06 (52.4)	1.13 (28.6)	0.20 (5.2)	15000 (1034)
3/8 NPT	2CT9	SS-FMA-NS6-2CT9	2.25 (57.2)	1.13 (28.6)	0.31 (7.9)	15000 (1034)
3/8 NPT	2CT12	SS-FMA-NS6-2CT12	2.50 (63.5)	1.13 (28.6)	0.44 (11.1)	15000 (1034)
3/8 NPT	2CT16	SS-FMA-NS6-2CT16	3.00 (76.2)	1.13 (28.6)	0.56 (14.3)	15000 (1034)
1/2 NPT	2CT9	SS-FMA-NS8-2CT9	2.50 (63.5)	1.37 (34.9)	0.31 (7.9)	15000 (1034)
1/2 NPT	2CT12	SS-FMA-NS8-2CT12	2.75 (69.9)	1.37 (34.9)	0.44 (11.1)	15000 (1034)
1/2 NPT	2CT16	SS-FMA-NS8-2CT16	3.25 (82.6)	1.37 (34.9)	0.56 (14.3)	15000 (1034)
3/4 NPT	2CT9	SS-FMA-NS12-2CT9	2.56 (65.1)	1.50 (38.1)	0.31 (7.9)	10000 (690)
3/4 NPT	2CT12	SS-FMA-NS12-2CT12	2.81 (71.4)	1.50 (38.1)	0.44 (11.1)	10000 (690)
3/4 NPT	2CT16	SS-FMA-NS12-2CT16	3.39 (86.0)	1.50 (38.1)	0.56 (14.3)	10000 (690)
1 NPT	2CT12	SS-FMA-NS16-2CT12	3.13 (79.4)	1.75 (44.5)	0.44 (11.1)	10000 (690)
1 NPT	2CT16	SS-FMA-NS16-2CT16	3.63 (92.2)	1.75 (44.5)	0.56 (14.3)	10000 (690)

**Female NPT Threads to 60 Series Male**

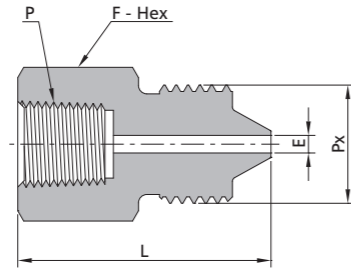

Female NPT Threads			60 Series Male			
P-Connection Type	Px-Connection Type	Ordering Number	Dimension, in. (mm)			Working Pressure psig (bar)
			L	F	E	
1/8 NPT	6MP4	SS-FMA-NS2-6MP4	1.19 (30.2)	0.63 (15.9)	0.08 (2.1)	15000 (1034)
1/8 NPT	6MP6	SS-FMA-NS2-6MP6	1.37 (34.9)	0.81 (20.6)	0.13 (3.2)	15000 (1034)
1/8 NPT	6MP9	SS-FMA-NS2-6MP9	1.63 (41.3)	1.19 (30.2)	0.19 (4.8)	15000 (1034)
1/4 NPT	6MP4	SS-FMA-NS4-6MP4	1.37 (34.9)	0.94 (23.8)	0.08 (2.1)	15000 (1034)
1/4 NPT	6MP6	SS-FMA-NS4-6MP6	1.63 (41.3)	0.94 (23.8)	0.13 (3.2)	15000 (1034)
1/4 NPT	6MP9	SS-FMA-NS4-6MP9	1.75 (44.5)	1.19 (30.2)	0.19 (4.8)	15000 (1034)
3/8 NPT	6MP4	SS-FMA-NS6-6MP4	1.44 (36.5)	1.13 (28.6)	0.08 (2.1)	15000 (1034)
3/8 NPT	6MP6	SS-FMA-NS6-6MP6	1.69 (42.9)	1.13 (28.6)	0.13 (3.2)	15000 (1034)
3/8 NPT	6MP9	SS-FMA-NS6-6MP9	1.81 (46.0)	1.19 (30.2)	0.19 (4.8)	15000 (1034)
1/2 NPT	6MP4	SS-FMA-NS8-6MP4	1.69 (42.9)	1.37 (34.9)	0.08 (2.1)	15000 (1034)
1/2 NPT	6MP6	SS-FMA-NS8-6MP6	1.94 (49.2)	1.37 (34.9)	0.13 (3.2)	15000 (1034)
1/2 NPT	6MP9	SS-FMA-NS8-6MP9	2.13 (54.0)	1.37 (34.9)	0.19 (4.8)	15000 (1034)
3/4 NPT	6MP4	SS-FMA-NS12-6MP4	1.75 (44.5)	1.50 (38.1)	0.08 (2.1)	10000 (690)
3/4 NPT	6MP6	SS-FMA-NS12-6MP6	2.00 (50.8)	1.50 (38.1)	0.13 (3.2)	10000 (690)
3/4 NPT	6MP9	SS-FMA-NS12-6MP9	2.19 (55.6)	1.50 (38.1)	0.19 (4.8)	10000 (690)
1 NPT	6MP4	SS-FMA-NS16-6MP4	2.00 (50.8)	1.75 (44.5)	0.08 (2.1)	10000 (690)
1 NPT	6MP6	SS-FMA-NS16-6MP6	2.25 (57.2)	1.75 (44.5)	0.13 (3.2)	10000 (690)
1 NPT	6MP9	SS-FMA-NS16-6MP9	2.44 (61.9)	1.75 (44.5)	0.19 (4.8)	10000 (690)

**Female NPT Threads to 60 Series Coned and Threaded Nipples**

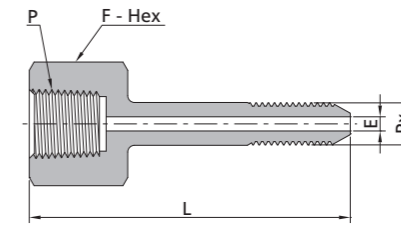

Female NPT Threads			60 Series Coned and Threaded Nipples			
P-Connection Type	Px-Connection Type	Ordering Number	Dimension, in. (mm)			Working Pressure psig (bar)
			L	F	E	
1/8 NPT	6CT4	SS-FMA-NS2-6CT4	1.87 (47.6)	0.63 (15.9)	0.08 (2.1)	15000 (1034)
1/8 NPT	6CT6	SS-FMA-NS2-6CT6	2.19 (55.6)	0.63 (15.9)	0.13 (3.2)	15000 (1034)
1/4 NPT	6CT4	SS-FMA-NS4-6CT4	2.13 (54.0)	0.94 (23.8)	0.08 (2.1)	15000 (1034)
1/4 NPT	6CT6	SS-FMA-NS4-6CT6	2.50 (63.5)	0.94 (23.8)	0.13 (3.2)	15000 (1034)
1/4 NPT	6CT9	SS-FMA-NS4-6CT9	3.06 (77.8)	0.94 (23.8)	0.19 (4.8)	15000 (1034)
3/8 NPT	6CT4	SS-FMA-NS6-6CT4	2.13 (54.0)	1.13 (28.6)	0.08 (2.1)	15000 (1034)
3/8 NPT	6CT6	SS-FMA-NS6-6CT6	2.50 (63.5)	1.13 (28.6)	0.13 (3.2)	15000 (1034)
3/8 NPT	6CT9	SS-FMA-NS6-6CT9	3.13 (79.4)	1.13 (28.6)	0.19 (4.8)	15000 (1034)
1/2 NPT	6CT4	SS-FMA-NS8-6CT4	2.37 (60.3)	1.37 (34.9)	0.08 (2.1)	15000 (1034)
1/2 NPT	6CT6	SS-FMA-NS8-6CT6	2.75 (69.9)	1.37 (34.9)	0.13 (3.2)	15000 (1034)
1/2 NPT	6CT9	SS-FMA-NS8-6CT9	3.31 (84.2)	1.37 (34.9)	0.19 (4.8)	15000 (1034)
3/4 NPT	6CT4	SS-FMA-NS12-6CT4	2.44 (61.9)	1.50 (38.1)	0.08 (2.1)	10000 (690)
3/4 NPT	6CT6	SS-FMA-NS12-6CT6	2.81 (71.4)	1.50 (38.1)	0.13 (3.2)	10000 (690)
3/4 NPT	6CT9	SS-FMA-NS12-6CT9	3.38 (85.8)	1.50 (38.1)	0.19 (4.8)	10000 (690)
1 NPT	6CT4	SS-FMA-NS16-6CT4	2.69 (68.3)	1.75 (44.5)	0.08 (2.1)	10000 (690)
1 NPT	6CT6	SS-FMA-NS16-6CT6	3.10 (78.8)	1.75 (44.5)	0.13 (3.2)	10000 (690)
1 NPT	6CT9	SS-FMA-NS16-6CT9	3.69 (93.8)	1.75 (44.5)	0.19 (4.8)	10000 (690)

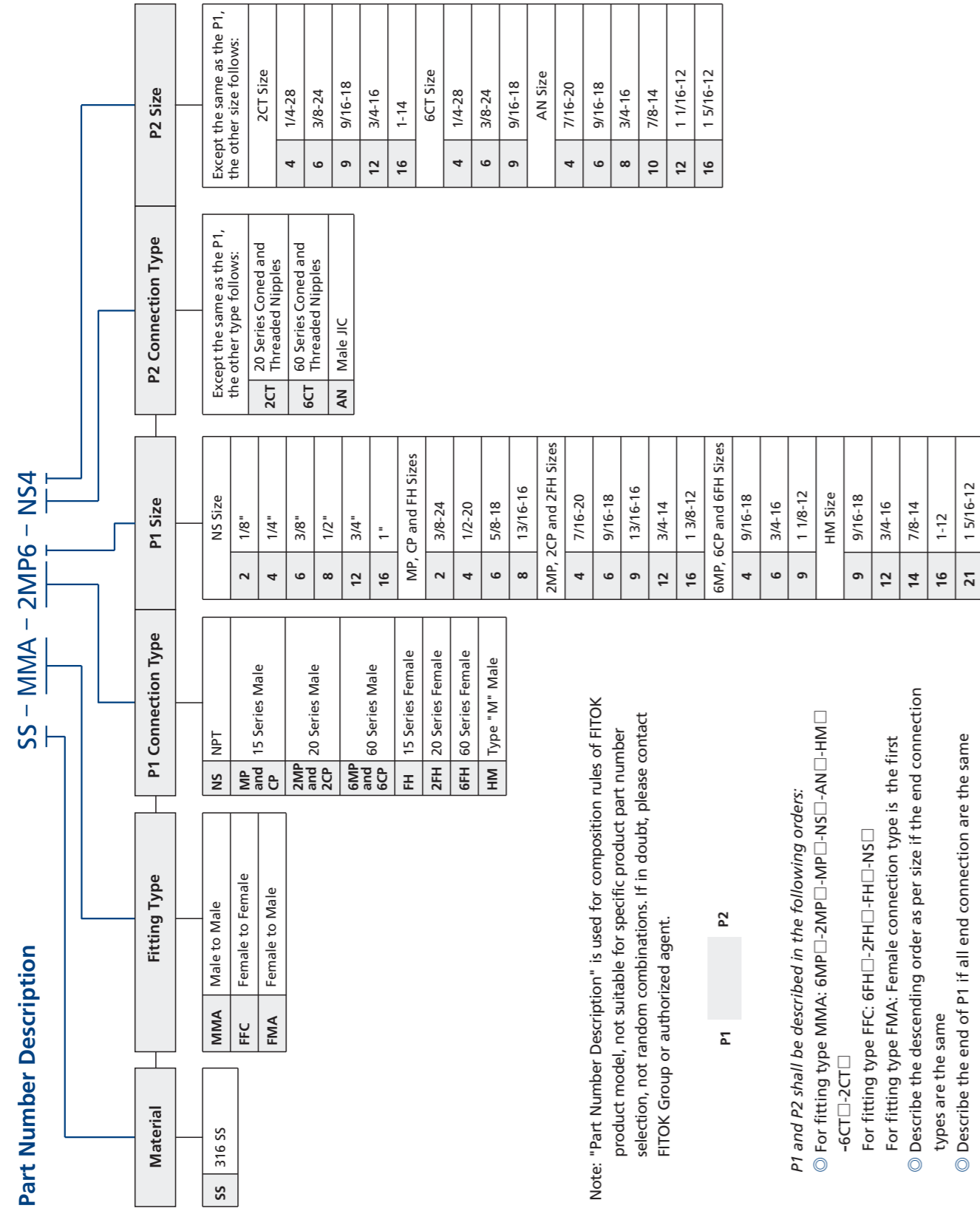

Part Number Description

Part Number Description